

# SurMountor



**SUR-3014FW120-12V**

FLEXIBLE STRIP introduction

Product specification

Lister: Lxlan

Assessor: 

Approver: 

## Features:

- Available in 12V DC maximum.
- Very bright & low power consumption.
- Operating temperature: -20~50°C.
- Long life span LED lights, more than 50,000 hours+.
- Adhesive back, peel & stick!
- Non-waterproof, IP20.

## Applications:

Ideal for sign letters and channel letters, concealed lights, room lighting, equipment.

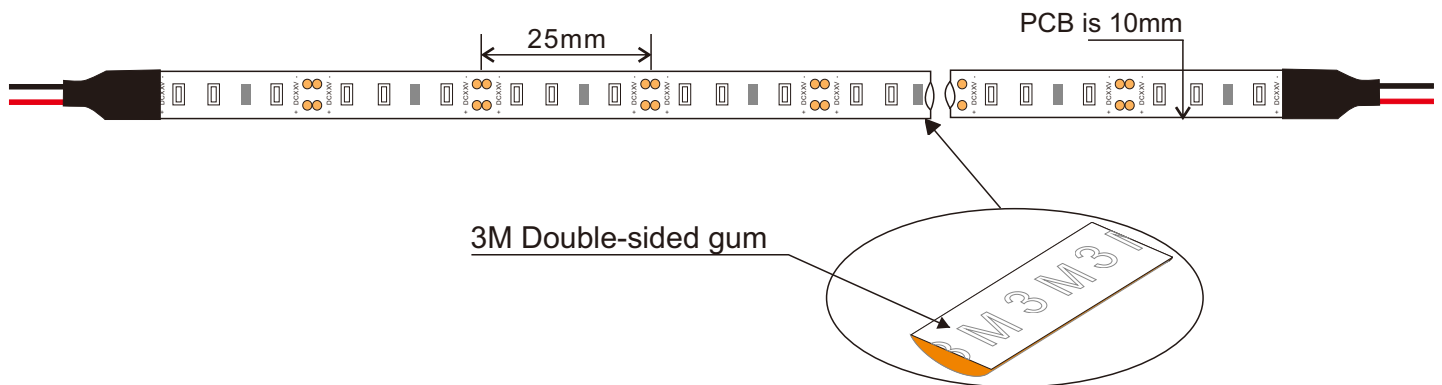

## Assembly drawing

### Top View



### Section



SUR-3014 120LED/meter							
Part number	Color	CRI	LED QTY/meter	Lumen/meter	Voltage	Power/meter	packing means
SUR-3014FWW120-12V	Warm white 	>80	120	1200	DC12V	14.4 watt	5 meter/reel
SUR-3014FNW120-12V	Natural white 	>80	120	1320	DC12V	14.4 watt	5 meter/reel
SUR-3014FCW120-12V	Cool white 	>80	120	1400	DC12V	14.4 watt	5 meter/reel

Radiation diagram

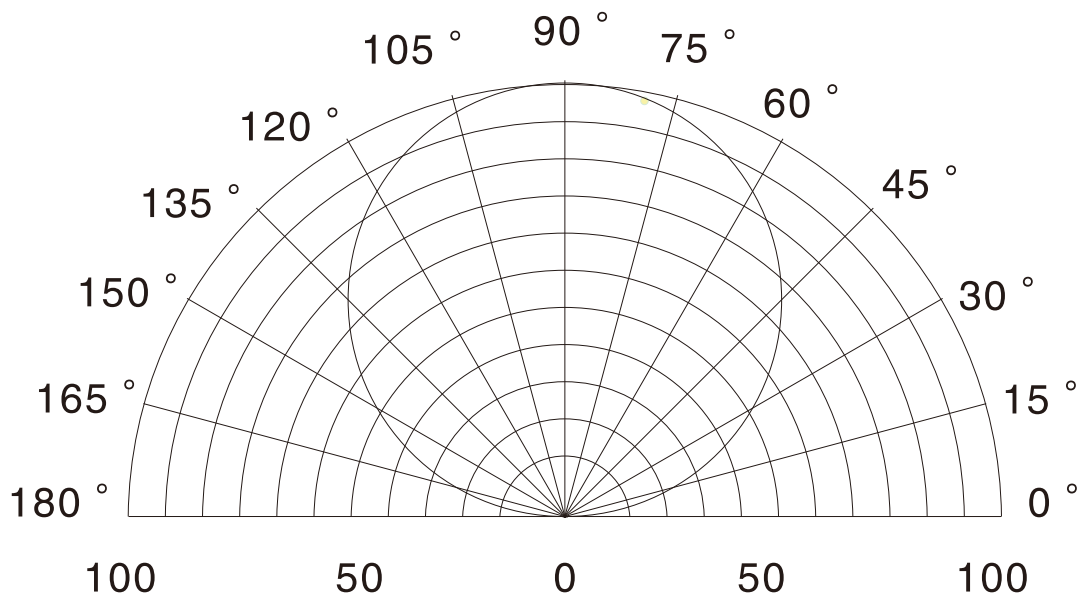

Relative luminous intensity Iv %

**LED Light distribution**



Color Spectrum (CRI80)

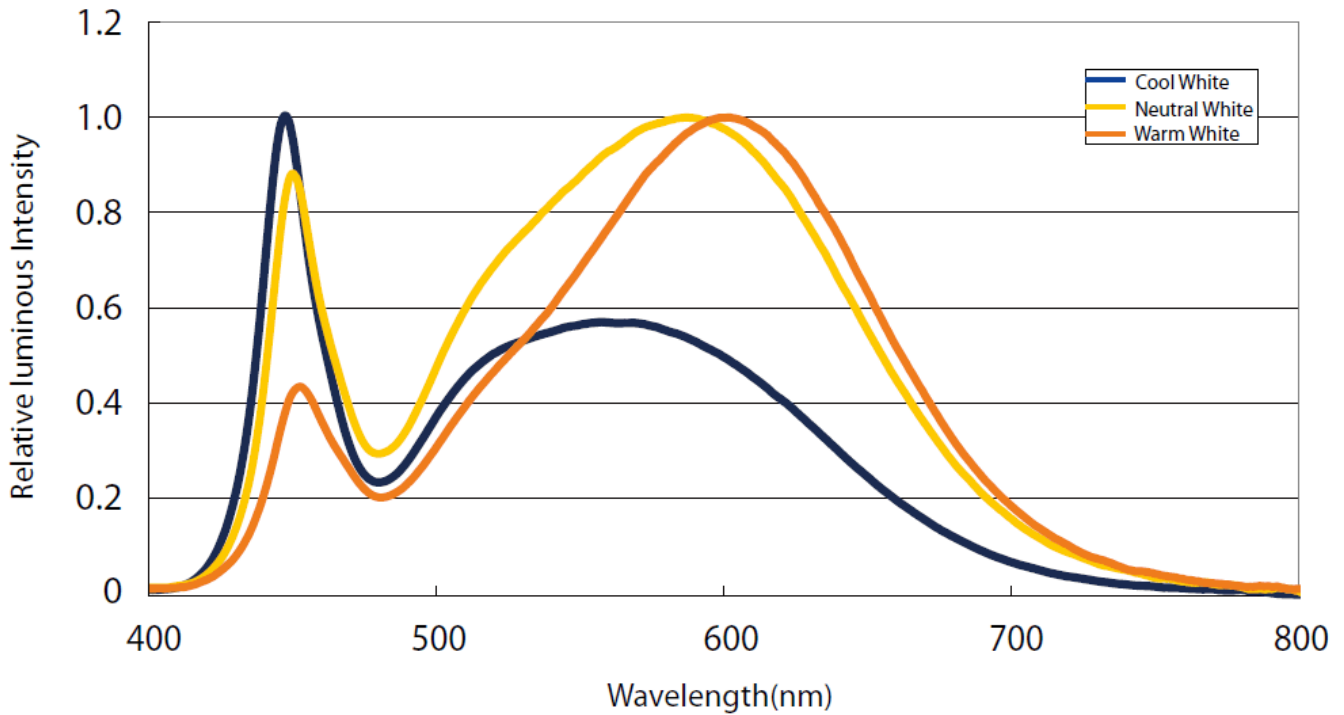

for: white LED

## How to connect flexible strip

Below shows you how to connect the flexible strip to power supplies.

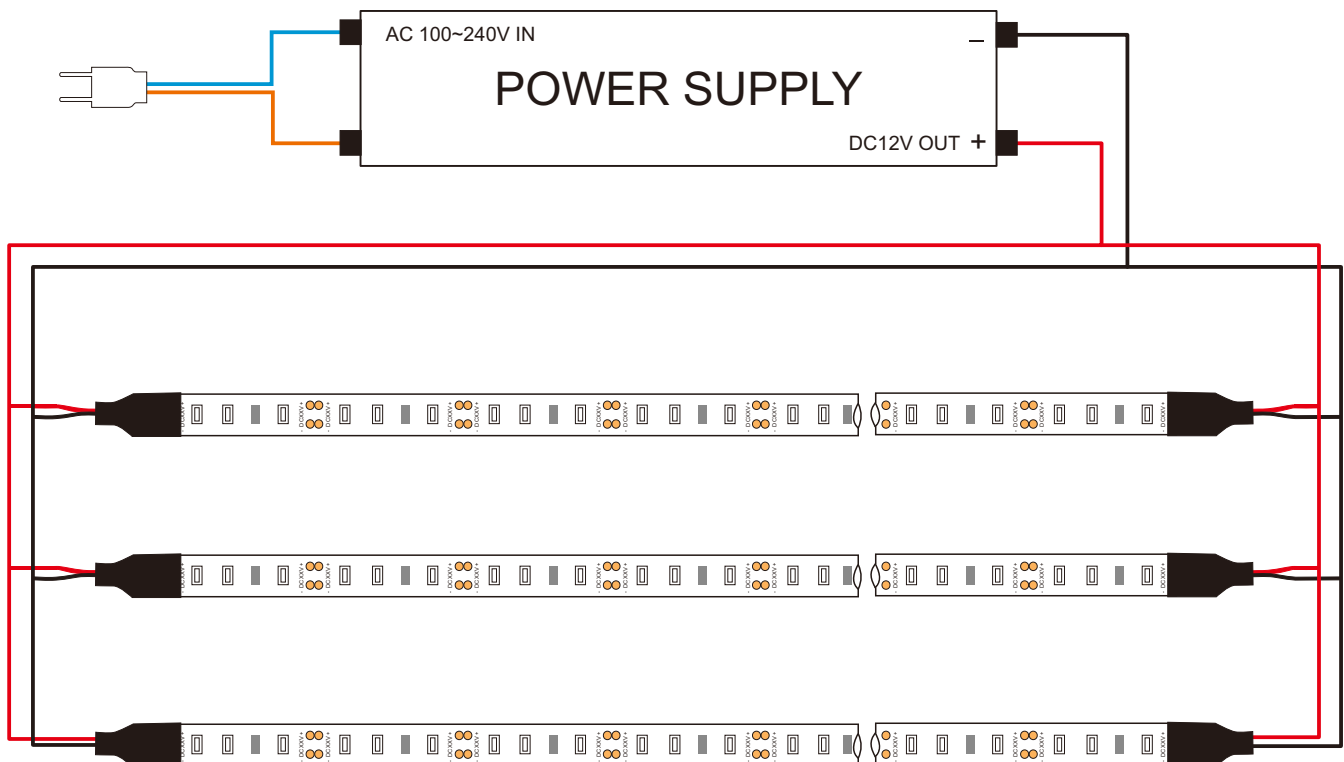

### Lux Diagram

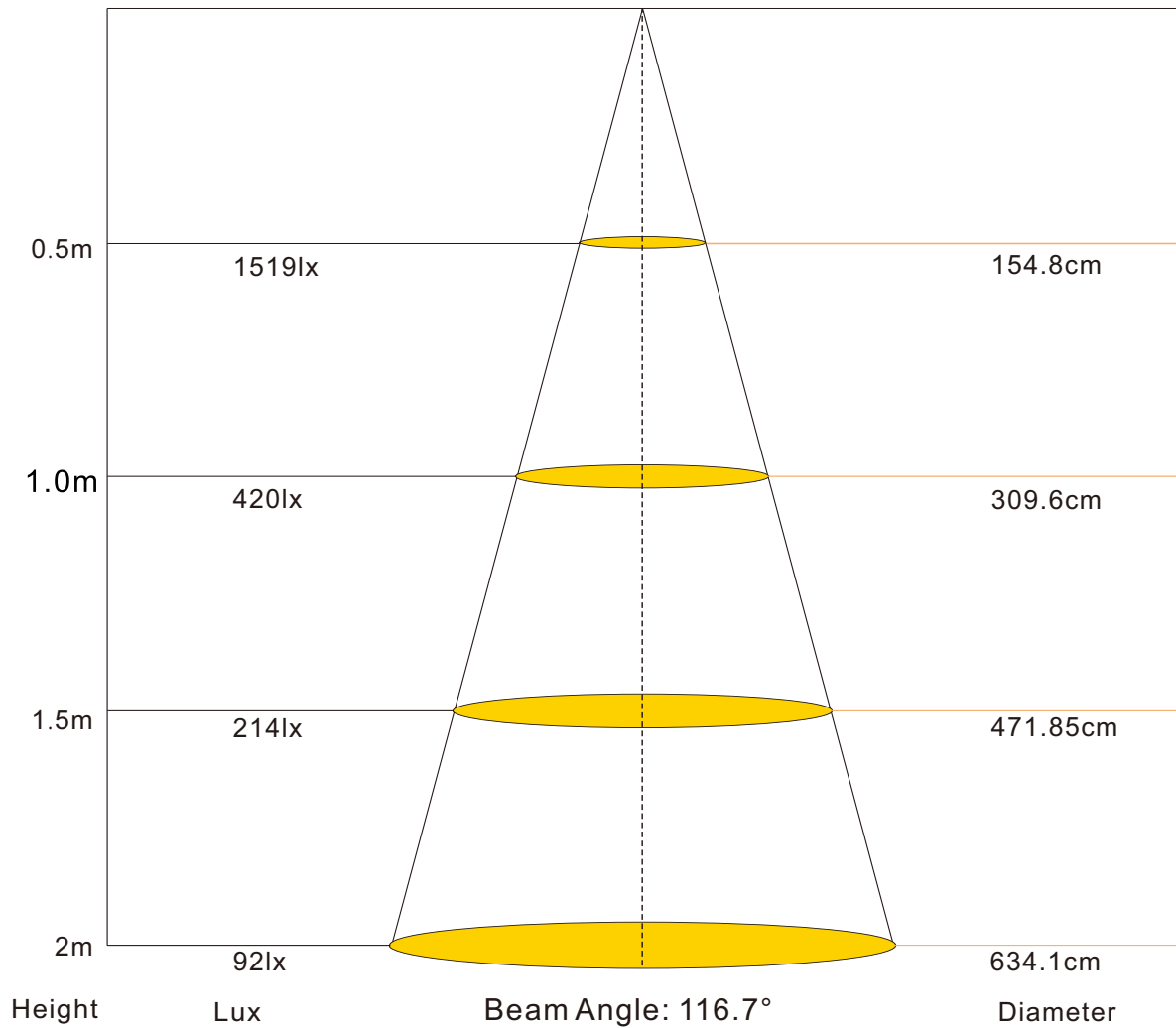

**3014 120LEDS-2700k**

### Lux Diagram

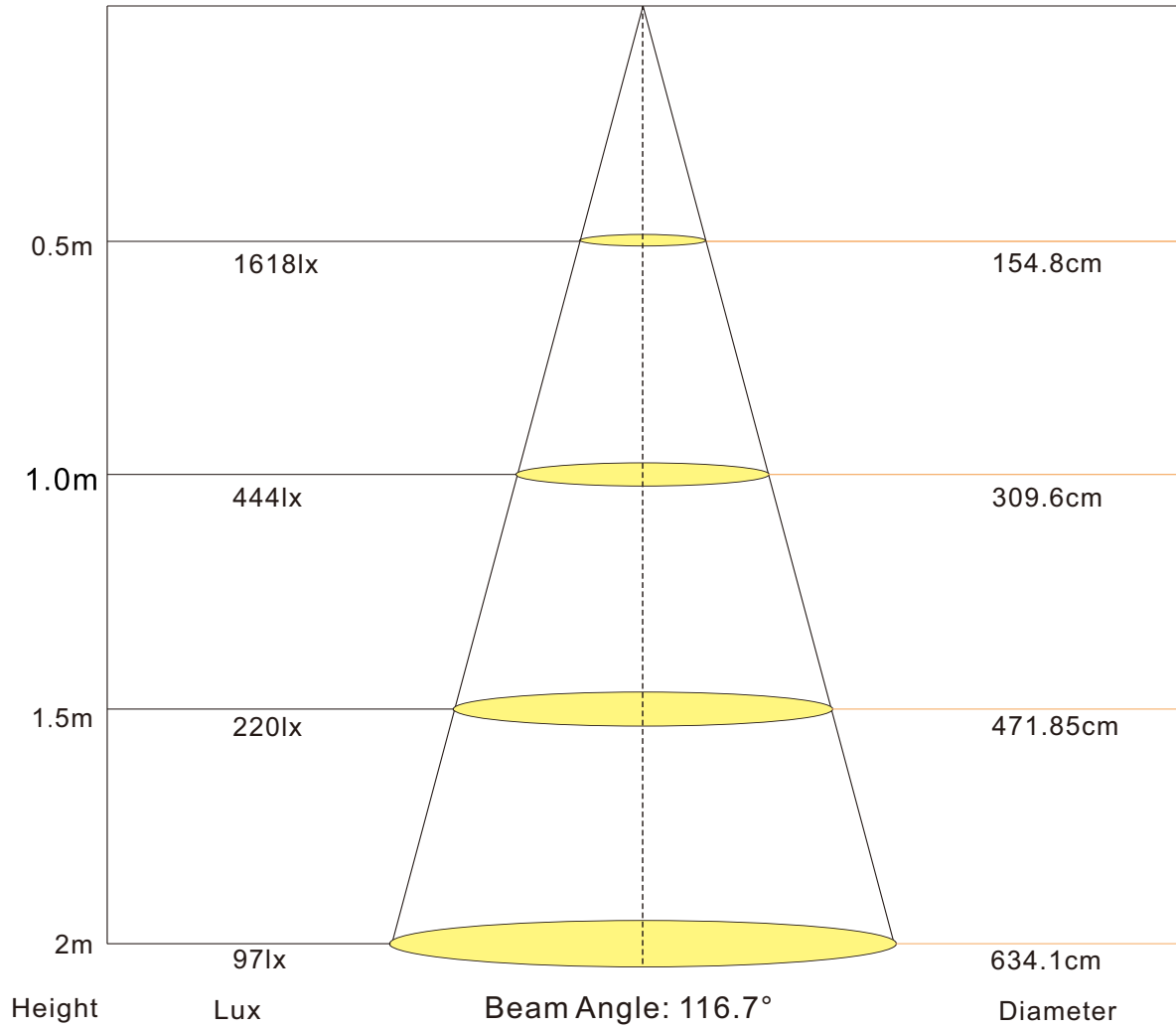

**3014 120LEDS-3000k**

### Lux Diagram

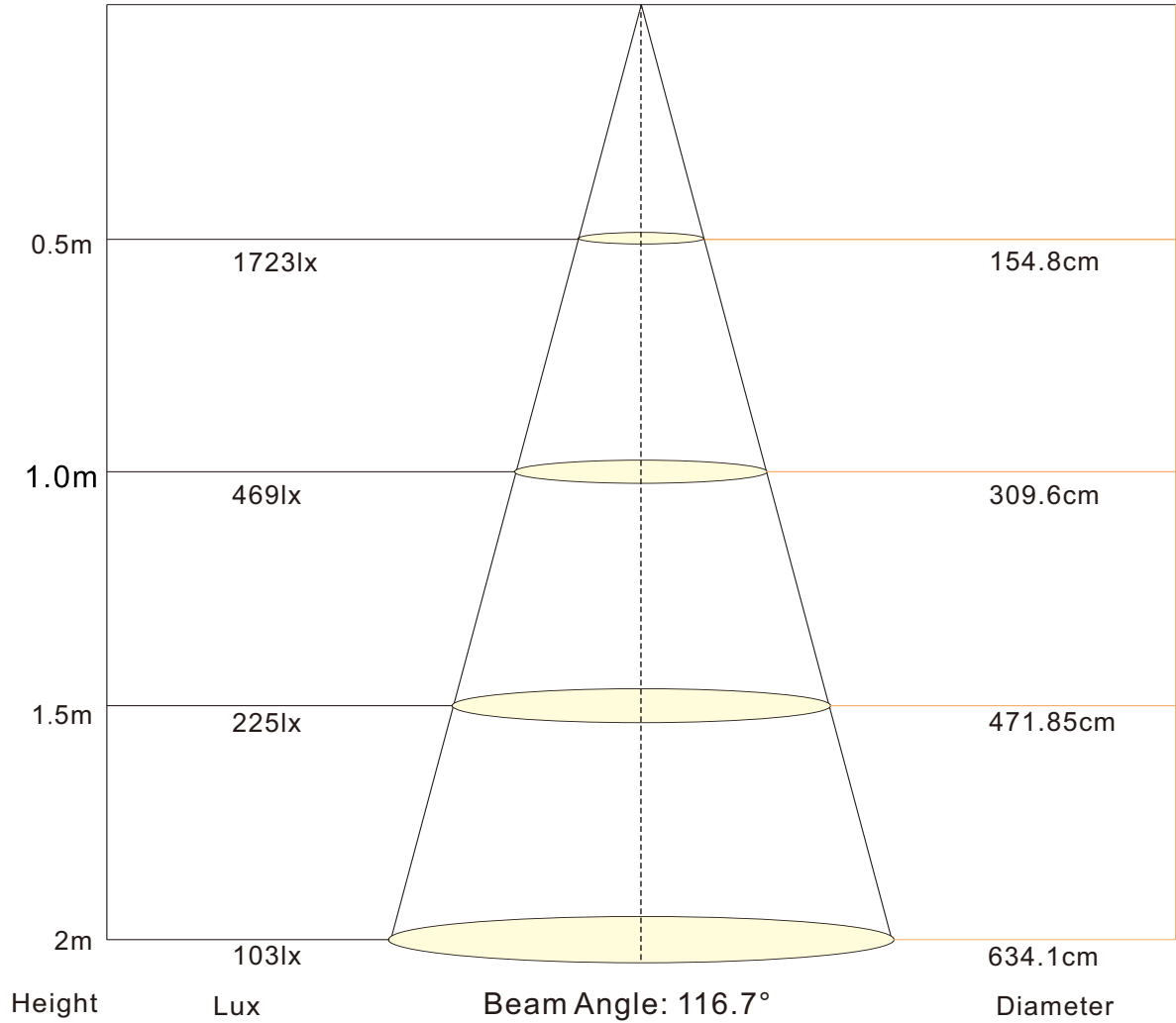

**3014 120LEDS-4000k**

### Lux Diagram

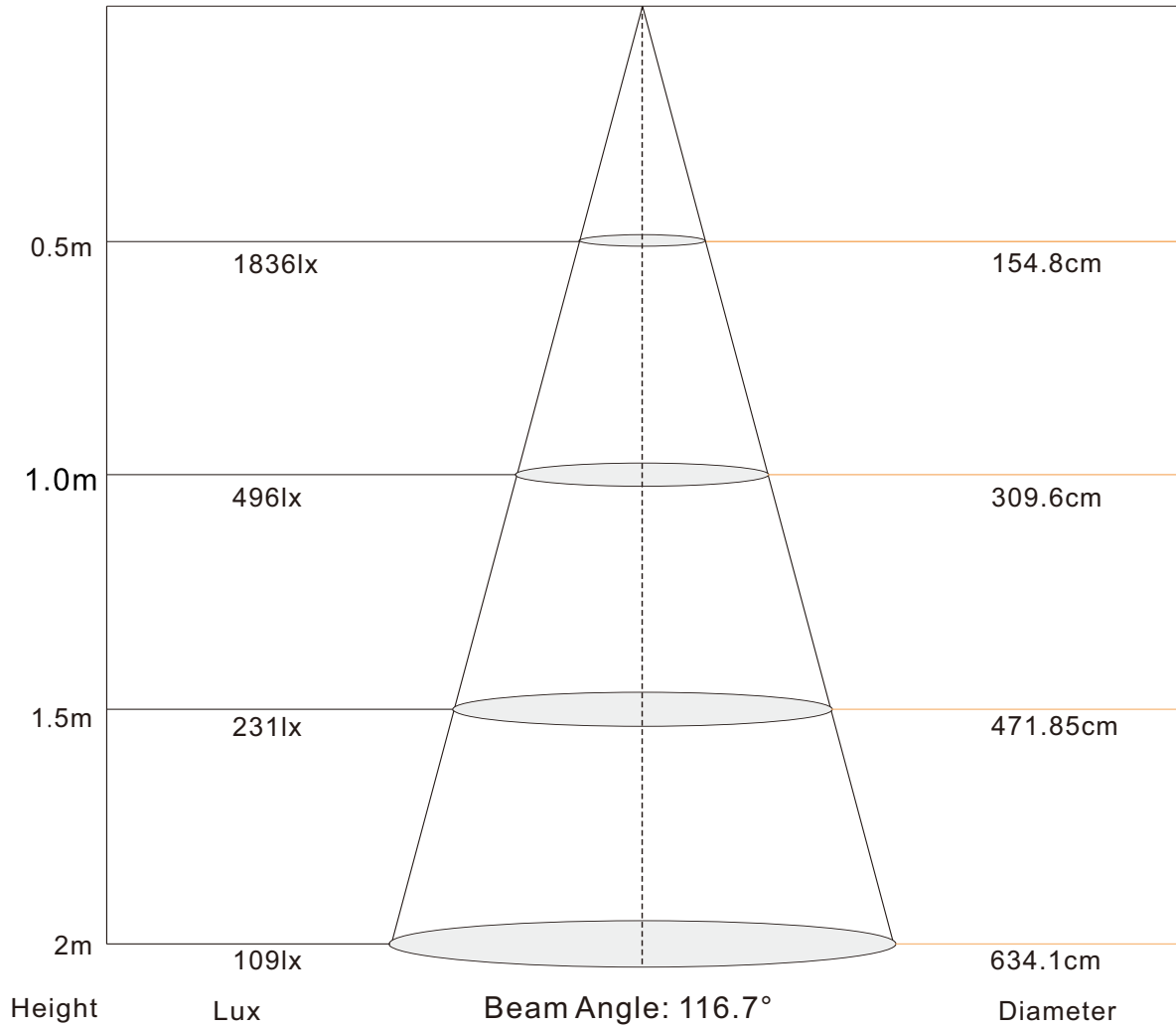

**3014 120LEDS-6000k**



## Package:



1 reel/bag



25 bags/Inner Box

Inner box  
size:25x26x31cm



50 Bags/Outer Box

Outer box  
size:34x52x27cm



Package: 5 meter strip in one reel, one reel in one anti-static bag, 25 bags put into one inner box, 2 inner box put into one carton.

**! Cautions:**

When install the led strip, please note the installation technique. The led strip can be bent, but not distorted, as shown below:

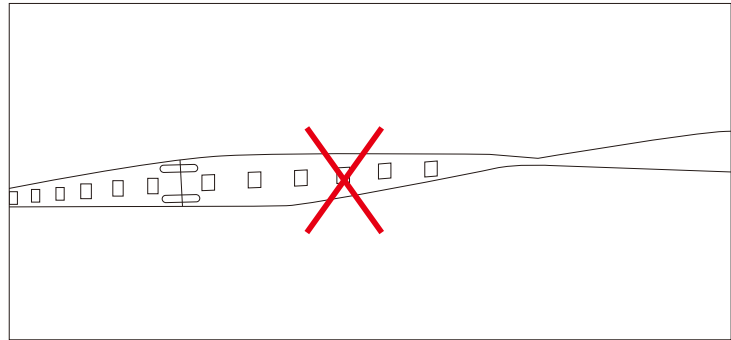
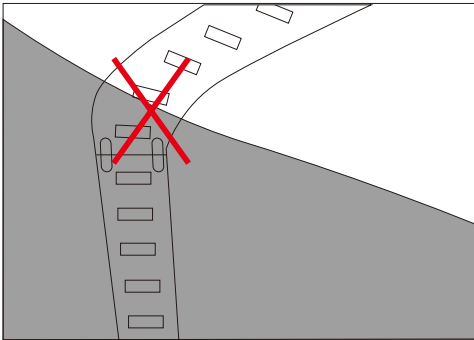
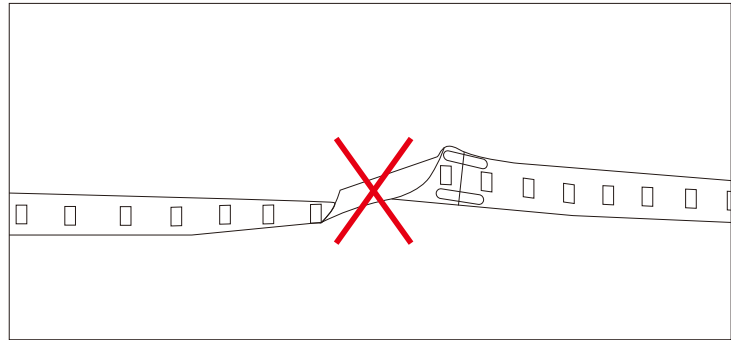
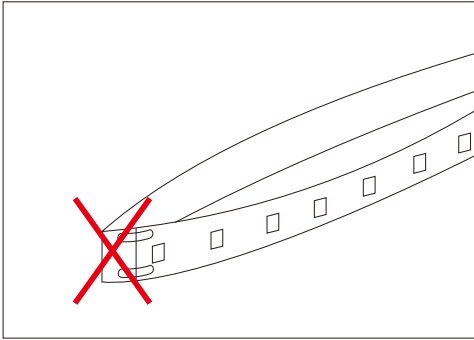

**Distortion(Wrong)**

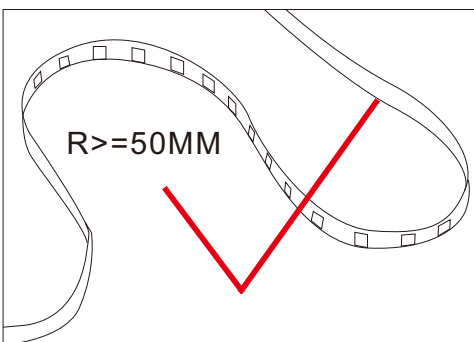

**Bend (Right)**