



# SurMountor



## **SUR-3527FWW+CW120-24V Dual Color**

Side edge emitting Flexible Strip introduction

Product specification

Lister: Lxlan

Assessor: 

Approver: 

## Features:

- Available in 24V DC maximum.
- Very bright & low power consumption.
- Operating temperature: -20~50°C.
- Long life span LED lights, more than 50,000 hours+.
- Adhesive back, peel & stick!
- Non-waterproof, IP20.

## Applications:

Ideal for sign letters and channel letters, concealed lights, room lighting, equipment.

## Assembly drawing

### Top View

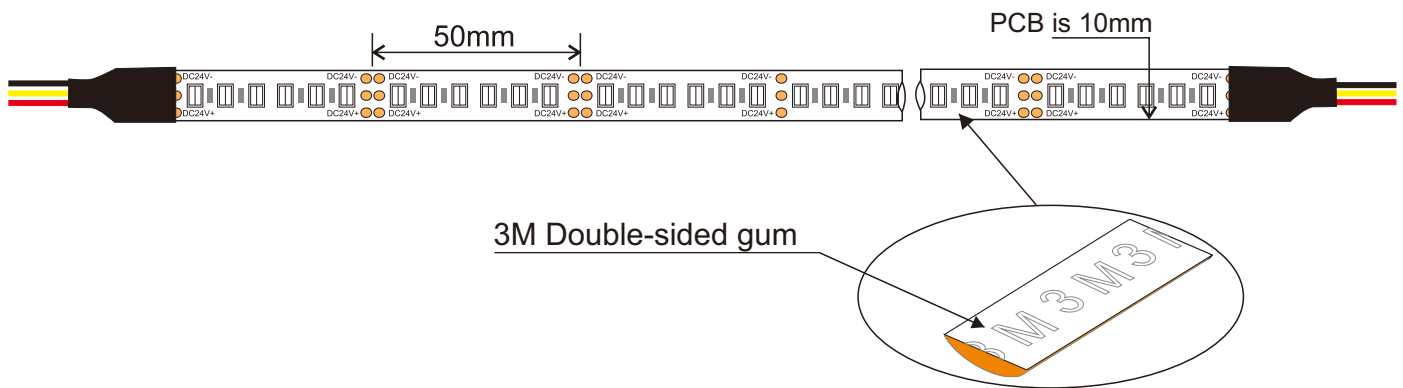

### Section



### Common anode

This flexible strip is made of 3527(2 in 1) LED, the PCB is 10mm white.

SMD3527,120LED/meter, Dual color.								
Part Number	Size	Color	Cut every (LEDS)	LED Qty/M	Lumen/M	Voltage	Power/m	Packing/m
SUR-3527FWW+CW120-24V	L5000*W10*H3	WW+CW	6	120	615+700	24V	14W	5 Meters/reel

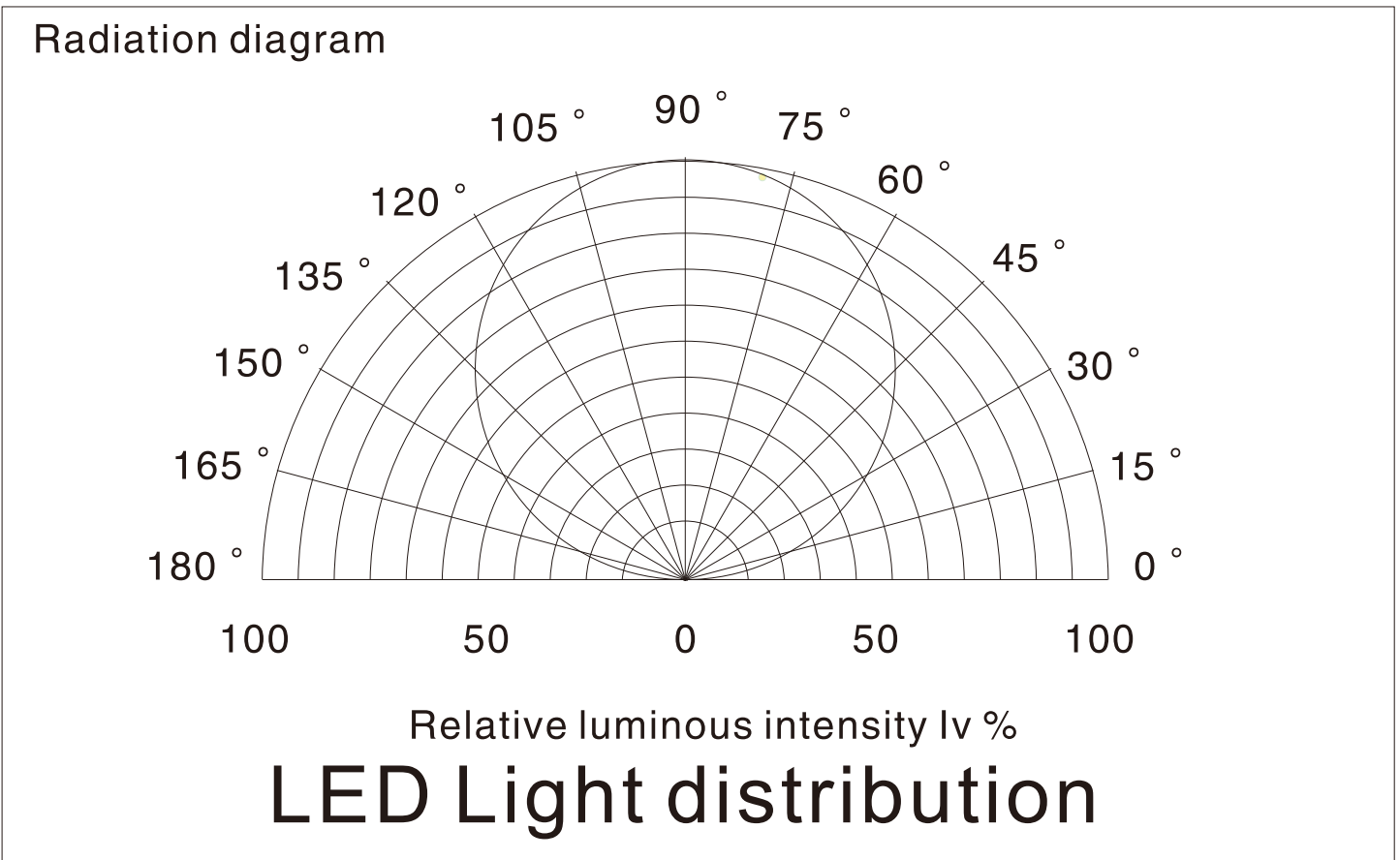

Color Spectrum (CRI80)

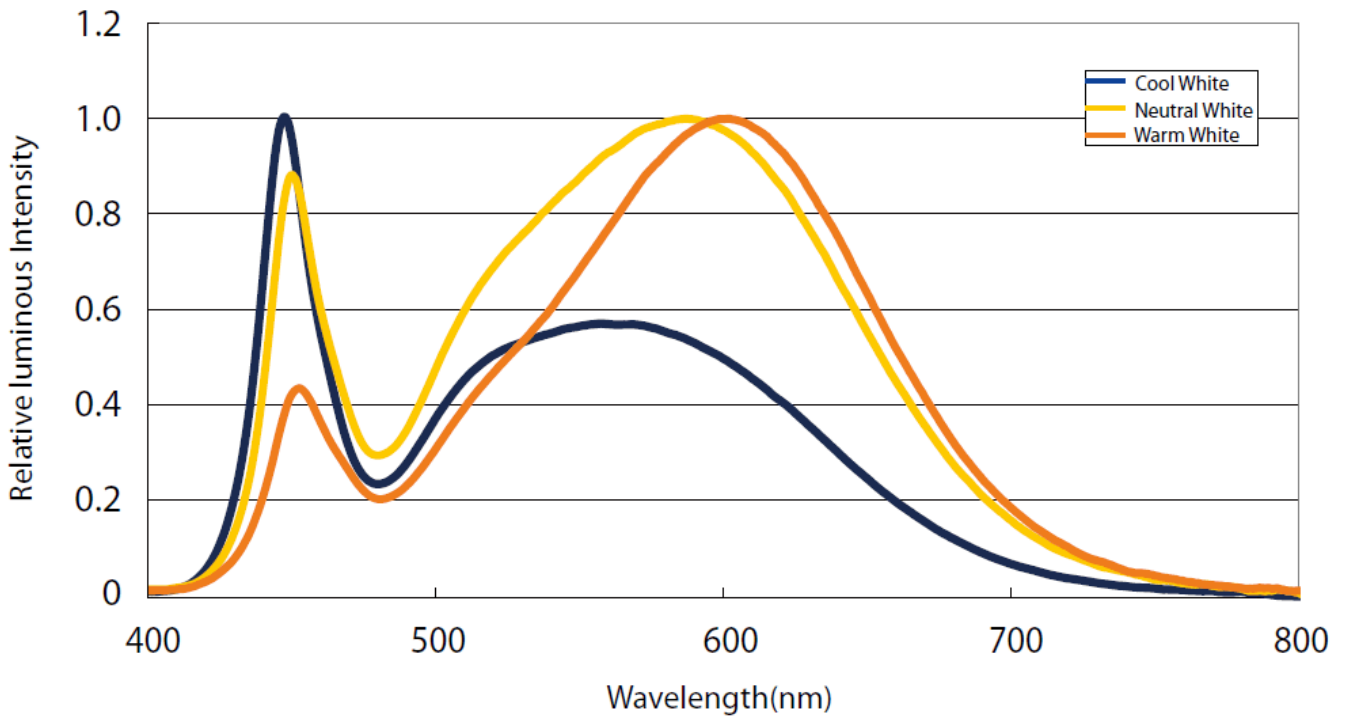

for: white LED

## How to connect flexible strip

Below shows you how to connect the flexible strip to power supplies.

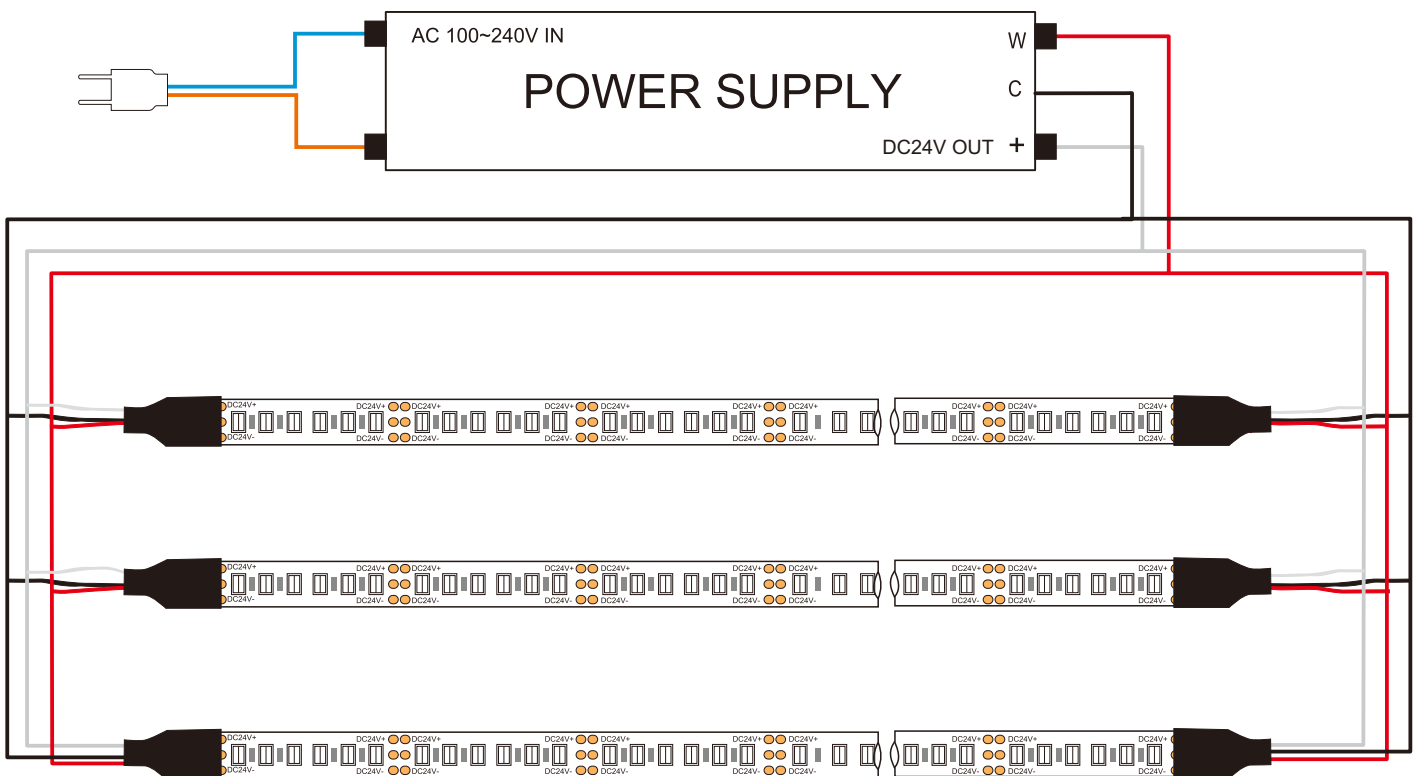

## Package:

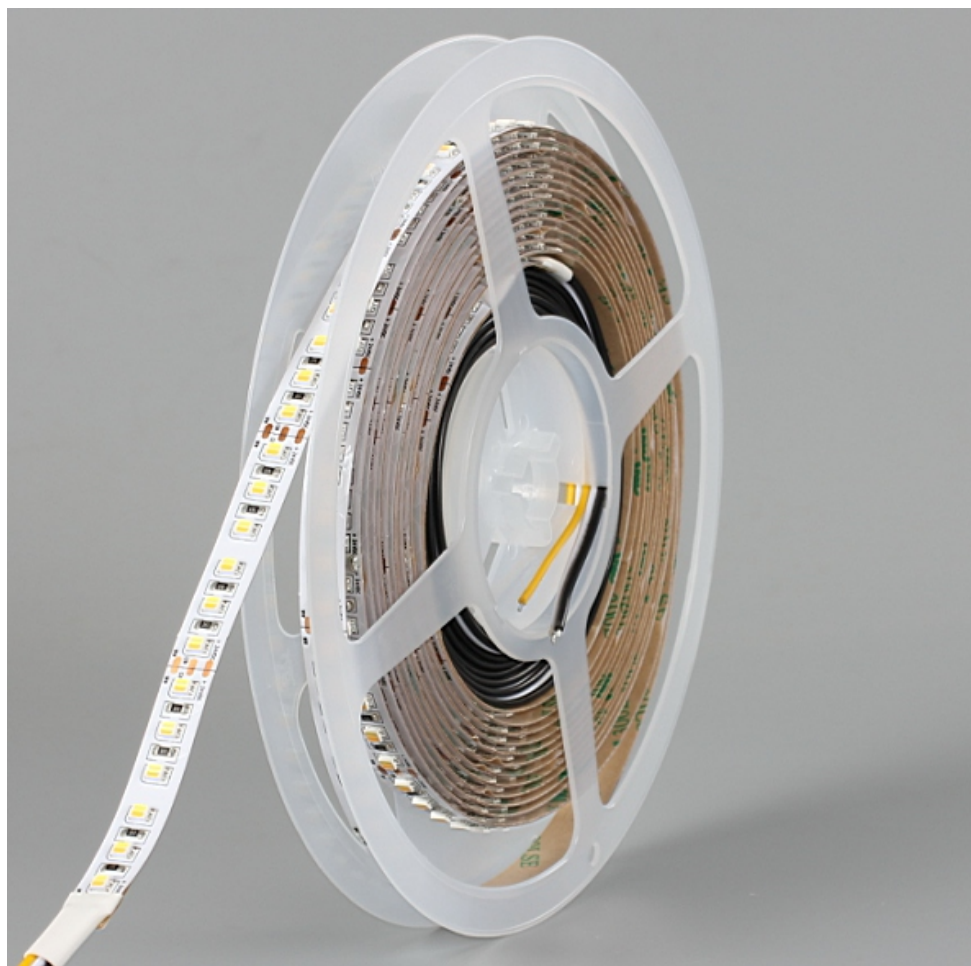

1 reel/bag



25 bags/Inner Box

Inner box  
size:25x26x31cm



50 Bags/Outer Box

Outer box  
size:34x52x27cm



Package: 5 meter strip in one reel, one reel in one anti-static bag, 25 bags put into one inner box, 2 inner box put into one carton.

**! Cautions:**

When install the led strip, please note the installation technique. The led strip can be bent, but not distorted, as shown below:

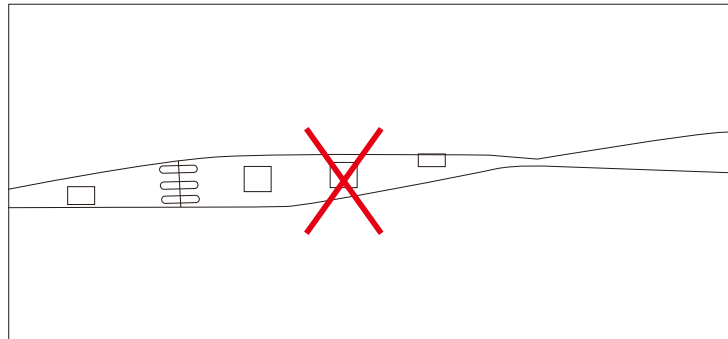
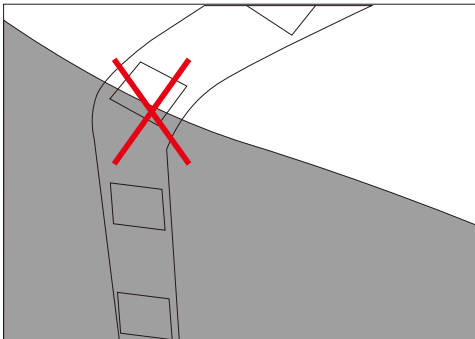
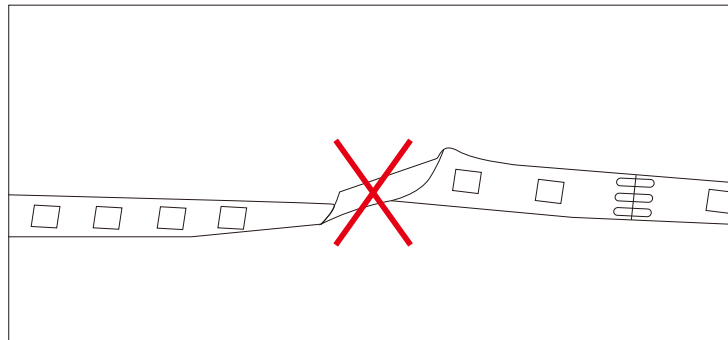
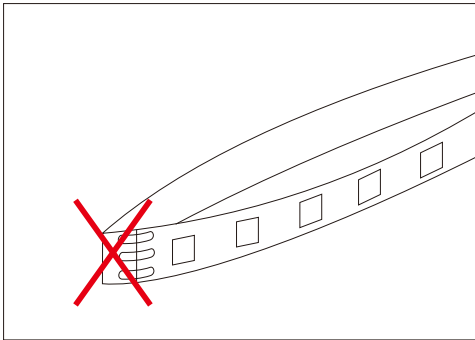

**Distortion(Wrong)**

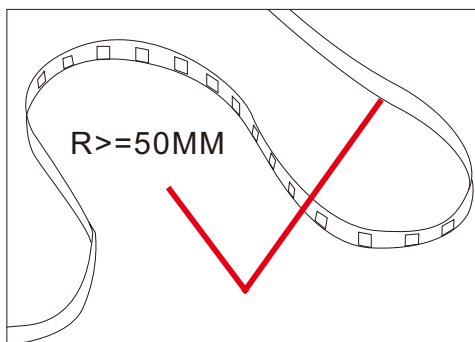

**Bend (Right)**