



SurMountor



SUR-3528DFW240-24V

Flexible led strip

Product specification

Lister: Lxlan

Assessor: 

Approver: 

Features:

- Available in 24V DC maximum.
- Very bright & low power consumption.
- Operating temperature: -20~50°C.
- Long life span LED lights, more than 50,000 hours+.
- Adhesive back, peel & stick!
- Non-waterproof, IP20.

Applications:

Engineering type, ideal for sign letters and channel letters, concealed lights, room lighting, equipment.

Assembly drawing

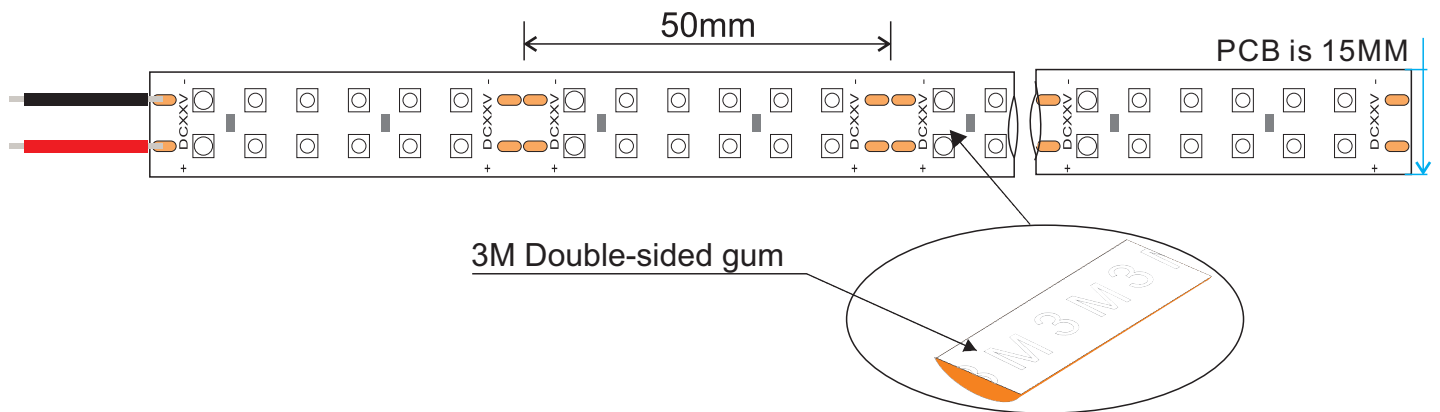

Top View



Section



SMD3528,240 LED/meter-Double lines

Part Number	Size	Color	Cut every (LEDS)	LED Qty/M	Lumen/M	Voltage	Power/m	Packing/m
SUR-3528DFWW240-24V	L5000*W15*H2	WW 	12	240	1200	24V	19.2W	5 Meters/reel
SUR-3528DFNW240-24V		NW 			1450			
SUR-3528DFCW240-24V		CW 			1600			

Radiation diagram

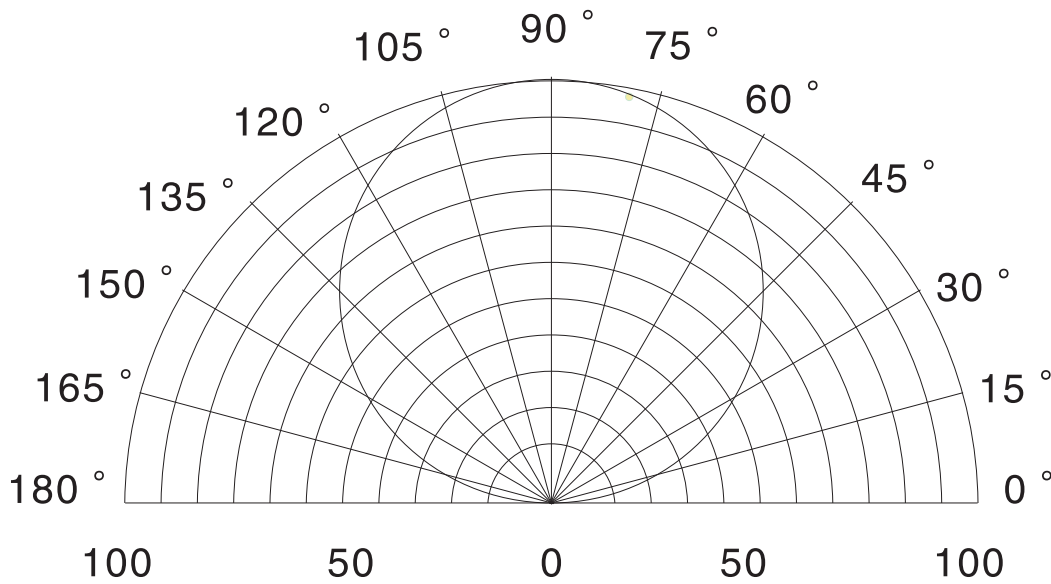

Relative luminous intensity Iv %

LED Light distribution



Color Spectrum (CRI80)

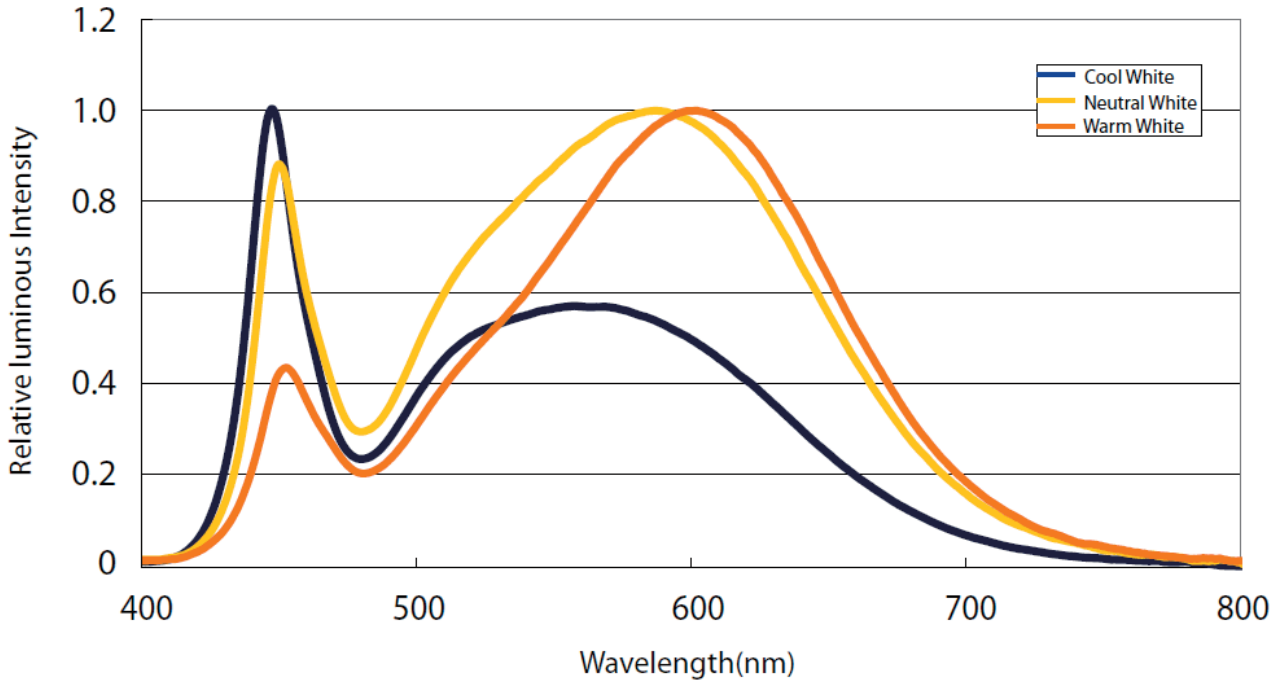

for: white LED

How to connect flexible strip

Below shows you how to connect the flexible strip to power supplies.

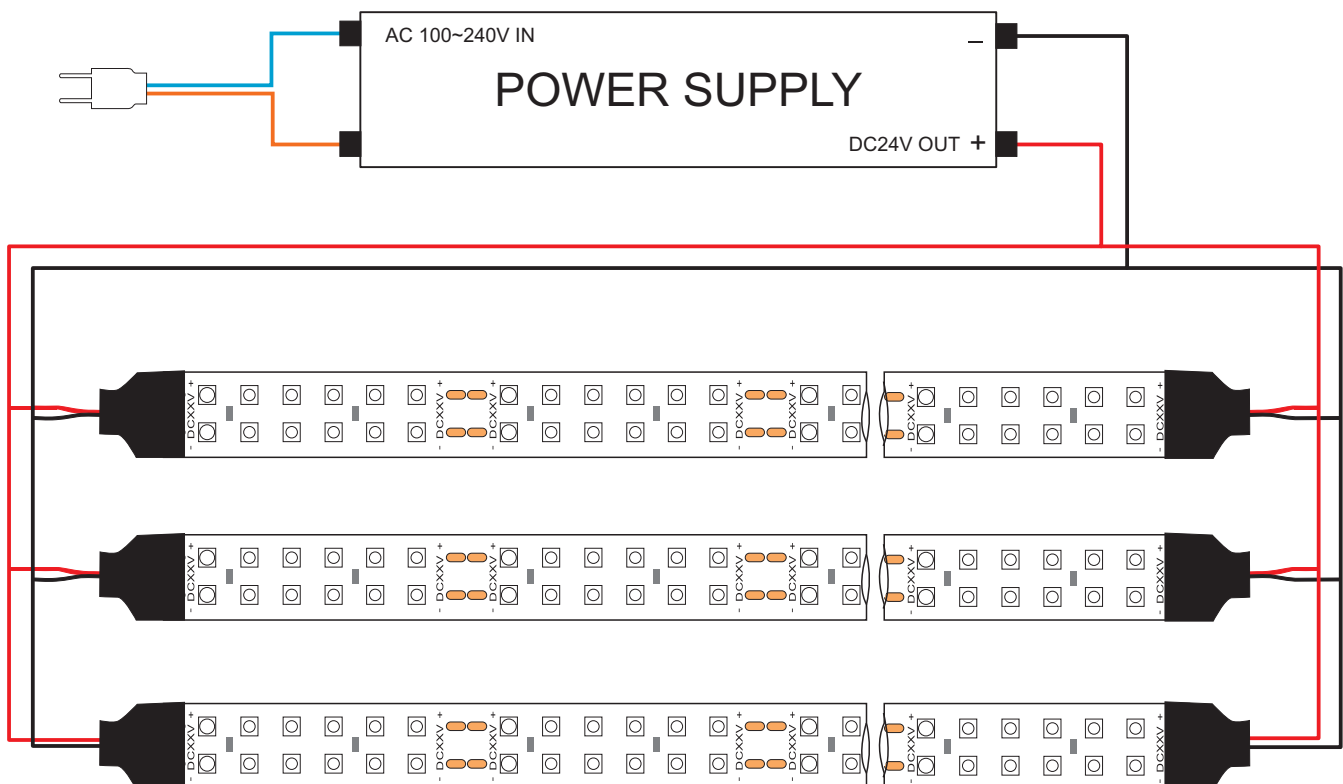

Package:



1 reel/bag



25 bags/Inner Box

Inner box
size:25x26x31cm



50 Bags/Outer Box

Outer box
size:34x52x27cm



Package: 5 meter strip in one reel, one reel in one anti-static bag, 25 bags put into one inner box, 2 inner box put into one carton.

! Cautions:

When install the led strip, please note the installation technique. The led strip can be bent, but not distorted, as shown below:

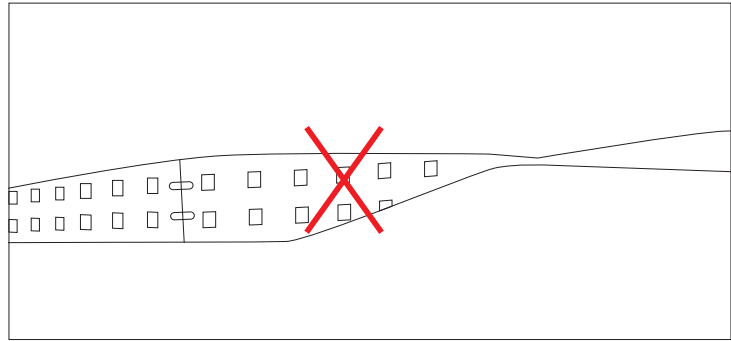
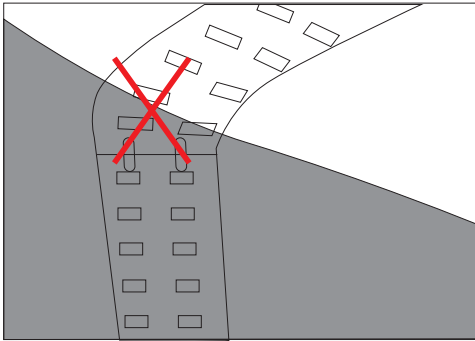
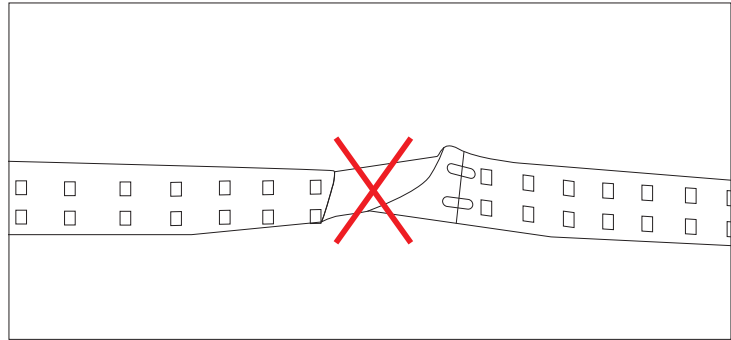
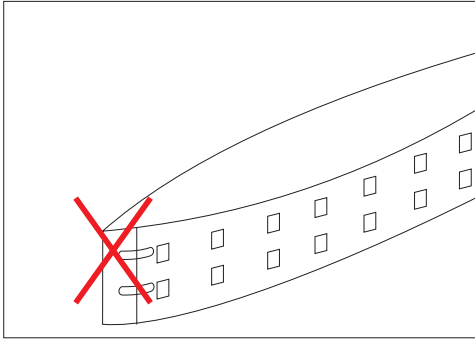

Distortion(Wrong)

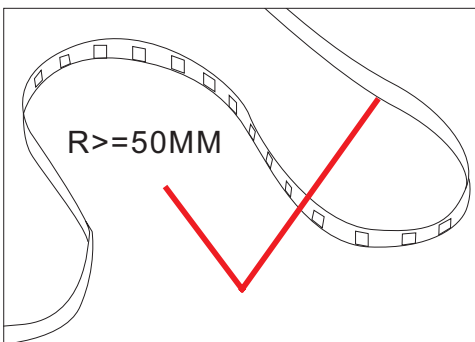

Bend (Right)