



N1010P-Side

LED Neon Flex Silicone Tube

Product Specification

LED strip colloid specifications comparison

Materials	Silicone flexible led strip	PVC flexible led strip	Notes
Main parameters			
Colloid features in -40°C	No crack after 30 days	Totally cracked	The low temperature resistant of silicone is superior than PVC or epoxy materials
Colloid features in 120°C	No obvious change after 72 hours	Colloid changed into yellow and deformed after 2 hours	The high temperature resistant of silicone is superior than PVC or epoxy
Colloid features in 180°C	No obvious change after 72 hours	Colloid changed into brown and some melted after 20 minutes	Over 150°C, PVC is easily hydrolyzed, Viscosity becomes weaken and easily separated
Steadily lighted in Seawater for 72 hours	No obvious change	Serious atomization on the surface	The waterproof grade of silicone led strip can reach to IP67, high resistance to acidic alkali and salt properties
Thermal conductivity	Good thermal conductivity	No thermal conductivity	Pvc and epoxy cannot conduct heat, while silicone has good thermal conductivity

Product Features

- Anti-yellowing and heat resisting silicone glue, chemical resistance acid and alkaline, available for extremely terrible outdoor environment.
- Uniform and soft luminance, no light spot.
- Super brightness large chip, golden wire welded and copper led holder for quicker heat dissipation, higher stability, longer life span.
- Leadless SMT technique (RoHS certificated), smooth welding joint, firm connection of led and pcb.

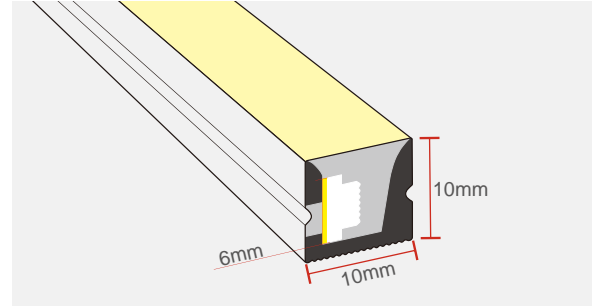
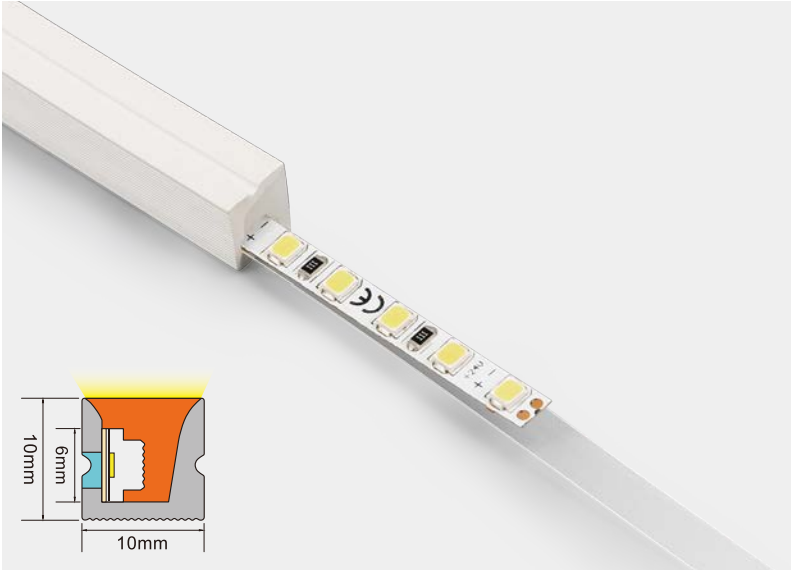

Size (mm)	10*10
PCB Limited (mm)	5
IP Grade	IP67
Working Temperature	-20 to 50°C
N.W.(G/M)	96

Recommend Led Strip parameters



SMD2835, 120 LED/meter PCB Width: 5MM								
Part number	Color	Lumen/M	Cut every (LEDS)	LED Qty/M	Voltage	Power/M	PCB Width	Packing/M
SUR-2835FWW120-24V	WW ■	1300	6	120	24V	14.4W	5mm	5 Meters/reel
SUR-2835FNW120-24V	NW ■	1450						
SUR-2835FCW120-24V	CW ■	1600						

Product System Solutions

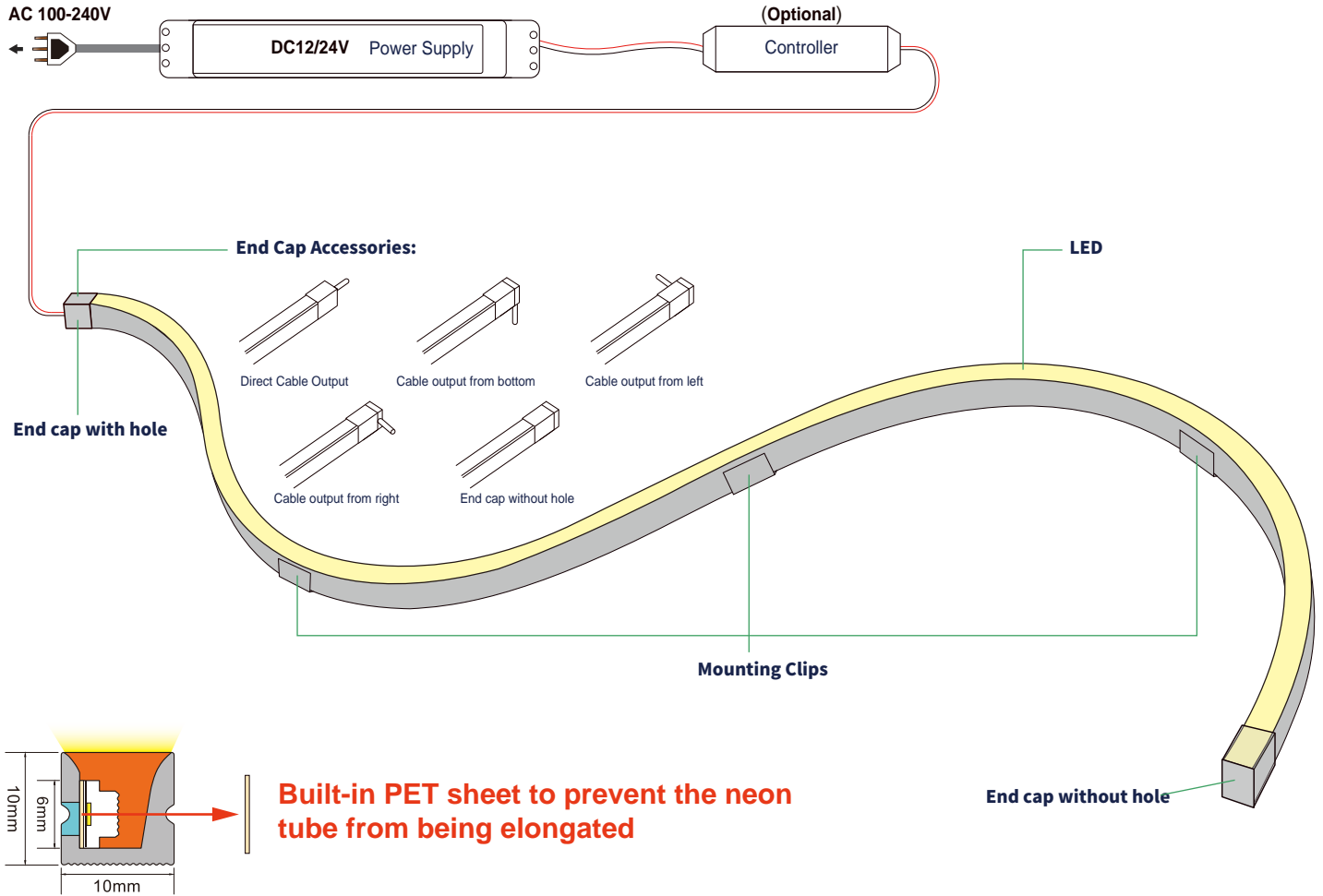

Installation Accessories

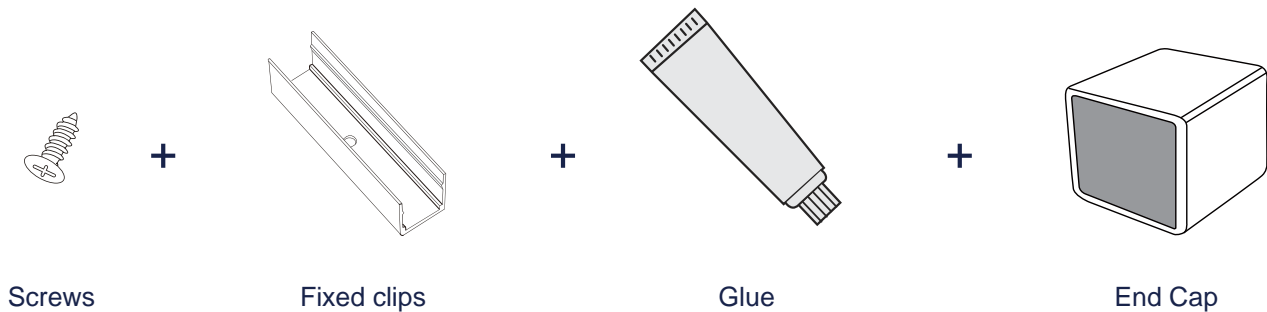

Installation of clip

1. Use screws to fix the clips or carriers on the mounting position

⚠ Clip. 3clips can be used for 1m

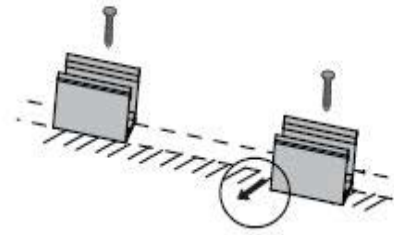
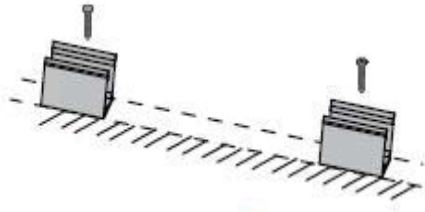

Installation of carrier

1. When installing the LED strip, install it from both ends at the same time, installation from one direction is prohibited.

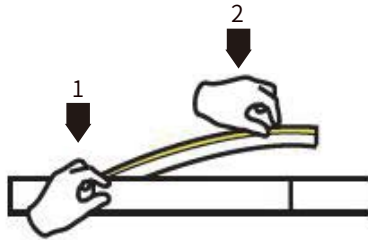
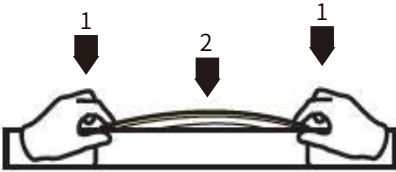

⚠ If the length of LED strip is over 2m, it is recommended to install by two persons.

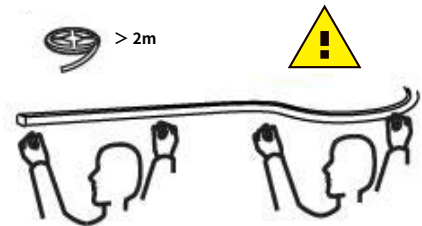

2. Use tool to disassemble carefully, and do not pull the LED strip directly.



⚠ If the length of LED strip is over 2m, it is recommended to disassemble by two persons.

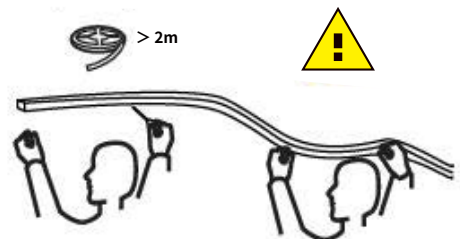

Cautions

- Please notice that the strips are not bendable to all directions. As the appropriate specific shape and degree, please follow the following instruction.
- LED strips are low voltage products, you must use the power supply (transformer). Please don't connect the led strip directly to the AC 110V or AC 220V. Otherwise, it will burn out the LED strips and lead to safety (security) accidents.
- Please read the specifications thoroughly before installation by professional staff to make sure the safe use.

Correct bending way

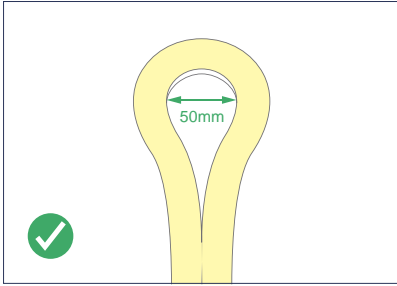

Face to the light surface, fold the strip, the minimum bending diameter is 50mm.

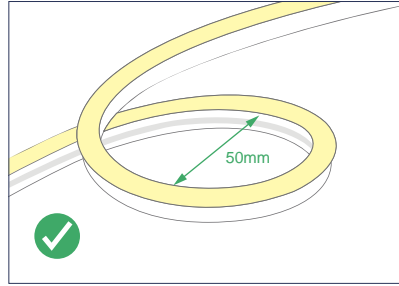

Light surface upwards, the strip is bendable to right or left naturally, the minimum bending diameter is 50mm.

Wrong bending way

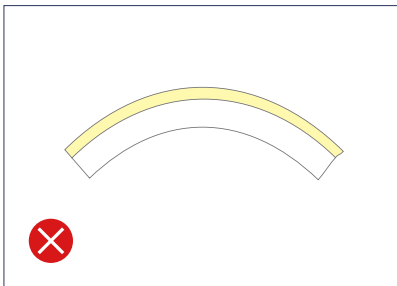

Face to the side surface (as the picture shows). Do not bend downward to damage the strip.



Face to the side surface (as the picture shows). Do not bend upward to damage the strip.

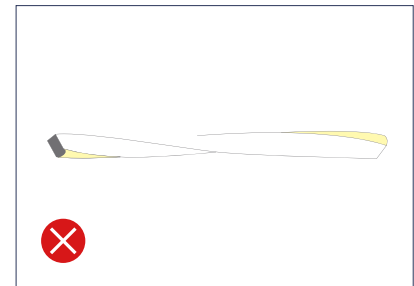

As the picture shows, please do not twist the strip, or it will be damaged.

Package of Neon Strip (5M/Roll)



5m/Roll



Pack in Anti-Static bag

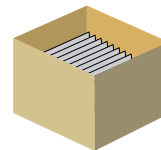

Pack in Inner Carton
Size: 25*25*30CM

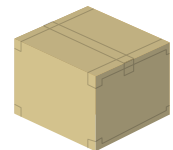

Pack with Outer Carton
Size: 56*27*30CM

Package of Silicone tube (100M/Roll)



100m/Roll



Each roll pack with expandable polyethylene
and compression film to fix.



1 Roll/box



Inner size: 355x355x155mm