

Mini DC Power Track Light











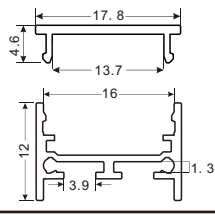

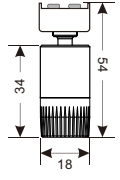
SUR-LTR Series

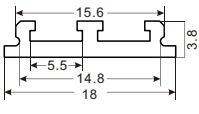
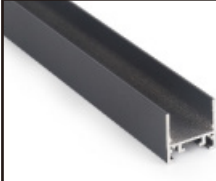
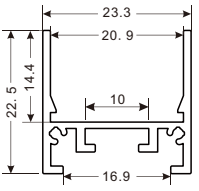

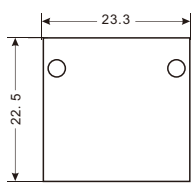
Product Specification

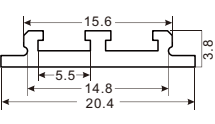

[Product Accessories Information]

Picture	Section size	Model Number	Description	Note
		LTR1812	Input voltage: DC24V Max current: 2.5A Color rendering : Ra > 80 CCT: 2700/3000/4000/6500K Certification: CE、 ROHS Warranty: 3 years	
		LTR-MSP01	Voltage : DC 12V-24V Total energy consumption : 1.0W Color rendering : Ra > 80 Certification: CE、 ROHS Warranty: 3 years	
		LTR01-S	Material:PC Surface Mounting Size:W18*H3.8mm [Inch size:*W0.71"*H0.15"] Length: 300mm/600mm/900mm	Track accessories
		LTR2224	Surface processing: Spraying surface Size:W23.3*H22.5mm [Inch size:*W0.92"*H0.88"] Length: 300mm/600mm/900mm	
		LTR2224-EC	End cap Material:PC Size:L22.5*W23.3*H8mm [Inch size:L0.88"*W0.92"*H0.31"]	
		LTR01-R	Material:PC Size:W20.4*H3.8mm [Inch size:*W0.80"*H0.15"] Length: 300mm/600mm/900mm	
	/	LTR02	Power Connector Max current: 5A	Power supply
	/	LTR03	Power Connector Max current: 5A	
	/	Universal A5570 wire rope + D003 bolt	Pendant cable 1.5m	Installation Accessories

[LTR1812]

Features

- Material: AL6063-T5, spraying surface
- Coating: Black
- Length: 300mm/600mm/900mm optional
- IP grade: IP20
- CCT: 2700/3000/4000/6500K optional
- CRI: 80
- Light efficiency: 70 lm/W
- Input voltage: DC24V
- Max current: 5A
- Lighting direction: downward
- Application: Indoor
- Certification: CE, ROHS
- Warranty: 3 years

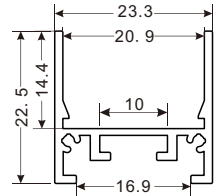

Photo-electric parameters

Model	Accessories picture	Beam Angle	Max current	Input Voltage (V)	Type Power (W)	CRI	CCT	Lumen (LM)
LTR-MSPO1		40°-25°	/	DC12-24V	1	>80	3000K	65
							4000K	70
							6000K	68
LTR1812		/	2.5A	DC24V	/	>80	2700K	/
							3000K	/
							4000K	/
							6500K	/

Note:

- 1, luminous flux is allowed to have a $\pm 10\%$ error range;
2. The above parameters are typical values.

How to install

01. LTR1812

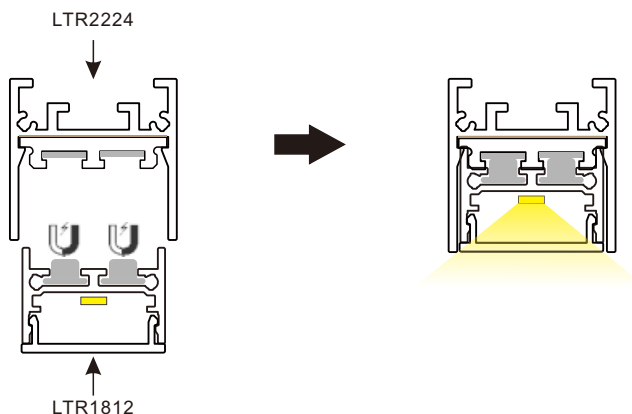

02. LTR-MRO01

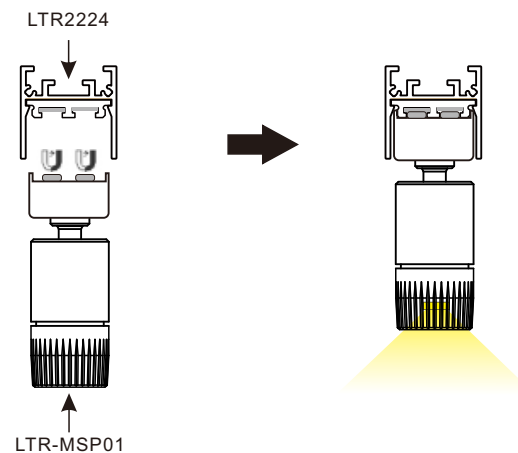

Application



Sketch map

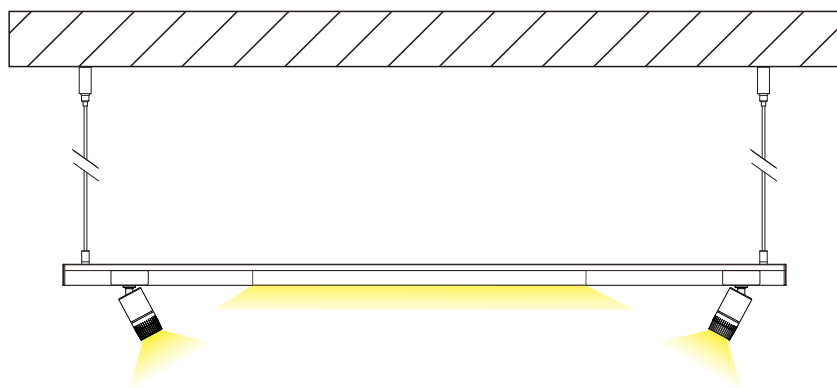

Attentions

- 1、 Non-professionals are prohibited from installing, disassembling and repairing the product.
- 2、 Avoid scratching, distortion and irregular bending of the product during installation; otherwise it may cause irreparable damage to the product.
- 3、 Please use professional cutting tools when cutting
- 4、 Do not use any acid or alkaline adhesive to fix products
- 5、 The product is only suitable for indoor dry places, can not be used in outdoor, seaside or wet environment.
- 6、 PC features: Each 10°C rise or drop will make diffuser extend or shrink 0.8mm/m, please confirm before processing and use

[LTR1812]

Features

- Material: AL6063-T5, spraying surface
- Coating: Black
- Length: 300mm/600mm/900mm optional
- IP grade: IP20
- CCT: 2700/3000/4000/6500K optional
- CRI: 80
- Light efficiency: 70 lm/W
- Input voltage: DC24V
- Lighting direction: downward
- Application: Indoor
- Certification: CE, ROHS
- Warranty: 3 years

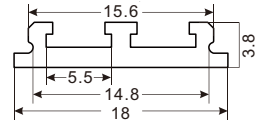

Accessories

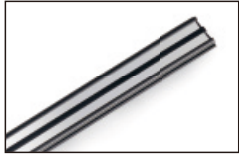

LTR01-S

Track

Surface Mounting



LTR02

Power Connector



LTR03

Power Connector



Endcap



LTR1812

How to install

01. LTR1812

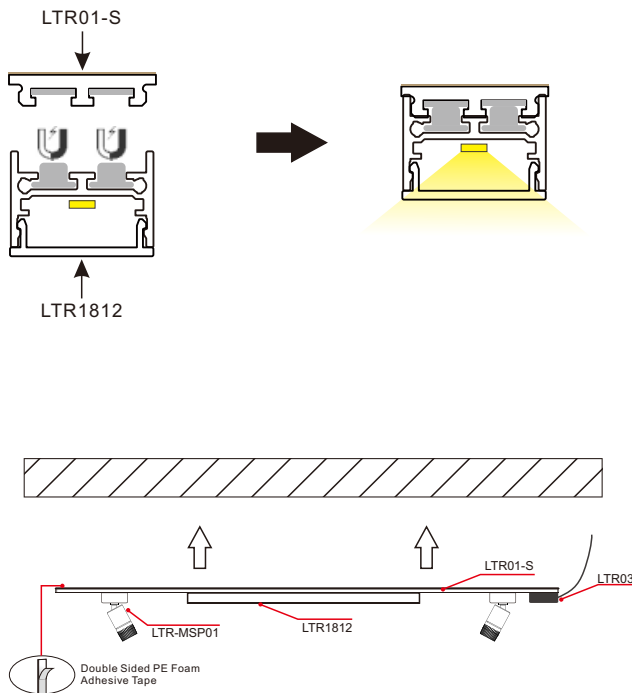

1. Put LTR-MSP01, LTR1812, LTR03 on LTR01-S, use 3M Tape with LTR01-S for installation in the right place.

02. LTR-MRO01

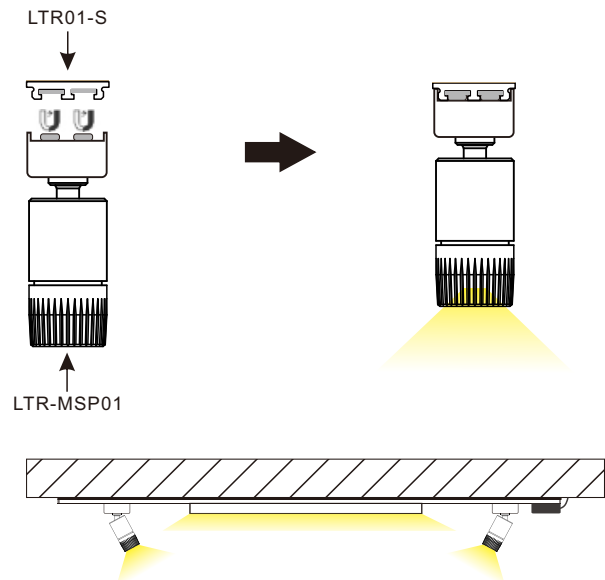

2. Connect power to LTR03

[LTR1812]

Features

- Material: AL6063-T5, spraying surface
- Coating: Black
- Length: 300mm/600mm/900mm optional
- IP grade: IP20
- CCT: 2700/3000/4000/6500K optional
- CRI: 80
- Light efficiency: 70 lm/W
- Input voltage: DC24V
- Max current: 5A
- Lighting direction: downward
- Application: Indoor
- Certification: CE、ROHS
- Warranty: 3 years

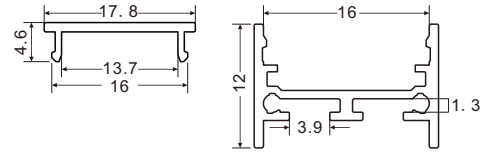

How to install

Magnets plate on the back for metal surface

01. LTR01-S

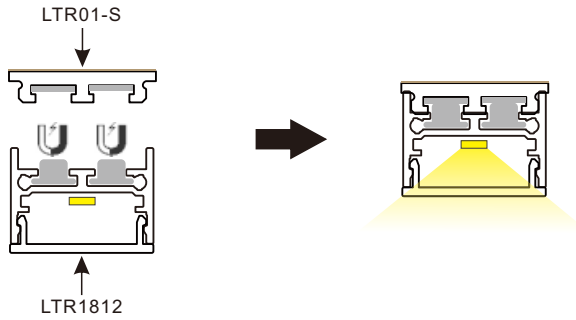

02. LTR2224

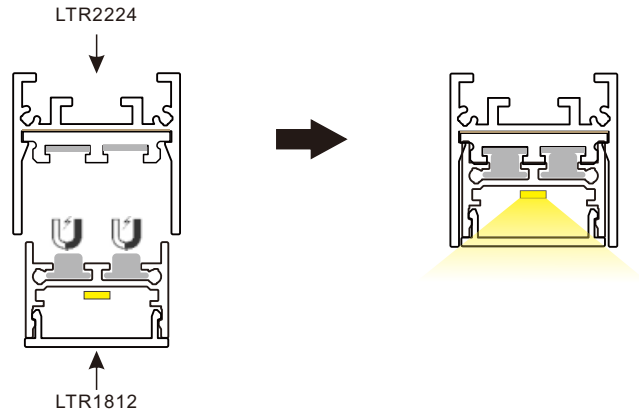

Photo-electric parameters

Model	Accessories picture	Light efficiency	Max current	Input Voltage (V)	Coating	CRI	CCT	Lumen (LM)
LTR1812		70 lm/W	2.5A	DC24V	Black	>80	2700K	/
							3000K	/
							4000K	/
							6500K	/

Note:

- 1, luminous flux is allowed to have a $\pm 10\%$ error range;
2. The above parameters are typical values.

[LTR-MSP01]

Features

- Voltage : DC 12V-24V
- Operating temperature : 0~45°C
- Lifetime : 40,000hrs / 70%
- Available color : 3000K, 4000K, 6000K
- Color rendering : Ra > 80
- Energy efficiency : 65lm/W
- Luminous Flux: 65lm
- Degree of protection : Ip20
- Beam angle : Standard 40° / Optional 25°
- Total energy consumption : 1.0W
- Certification: CE、ROHS
- Warranty: 3 years

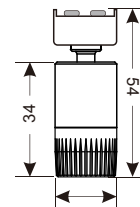

Photo-electric parameters

Beam Angle	Model	Length	Input Voltage (V)	Type Power (W)	CRI	CCT	Lumen (LM)
40°-25°	LTR-MSPO1	/	DC12-24V	1	>80	3000K	65
						4000K	70
						6000K	68

Note:

1. The above parameters were tested based on Ra80, 3000K, 40° light source;
2. luminous flux is allowed to have a ±10% error range;
3. The above parameters are typical values.

Product mechanical data



[Optical Parameter]

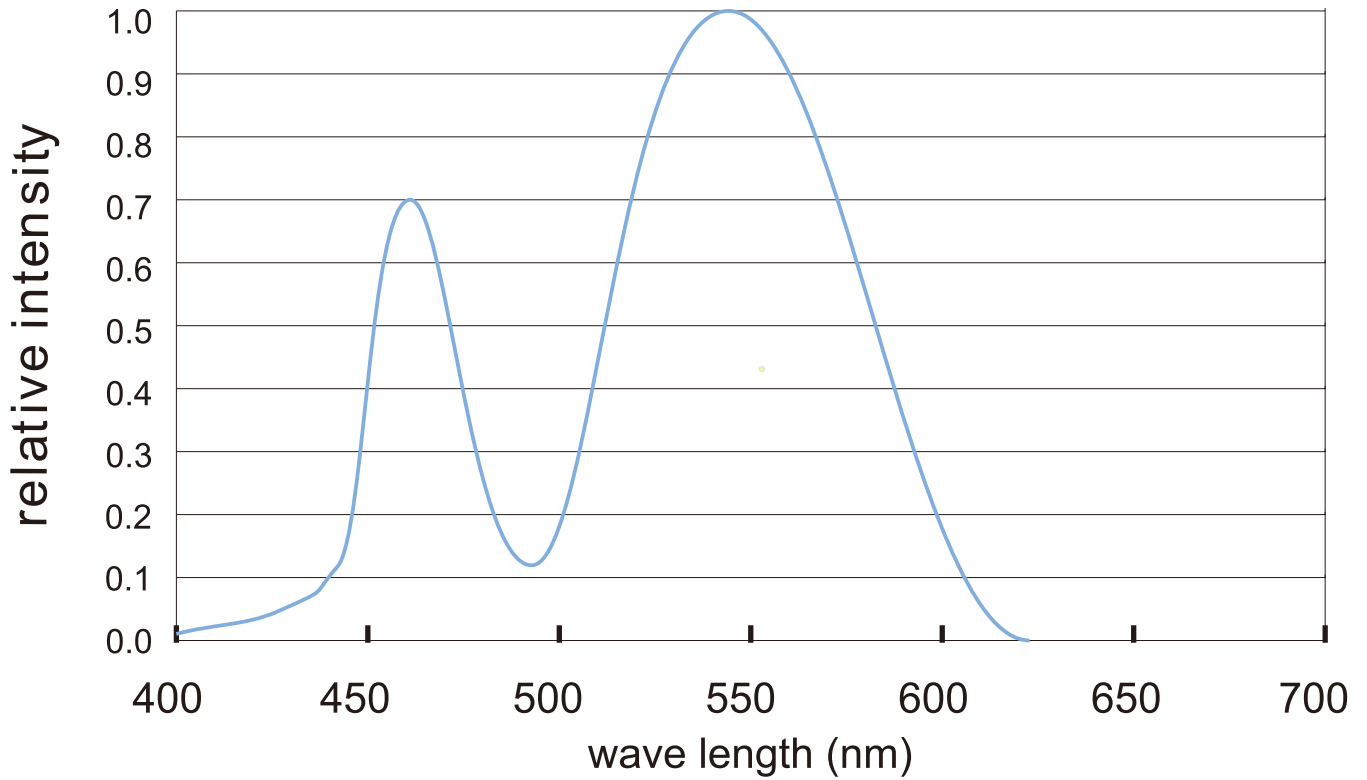

for: white LED

Radiation diagram

