

Features:

- 100mm has a address IC and is programmable.
- High brightness & low power consumption.
- SPI LED strip with controller.
- Long life span LED lights, more than 50,000 hours+.
- Adhesive back, peel & stick!
- Operating temperature: -20~50°C.
- Non-waterproof, IP20.

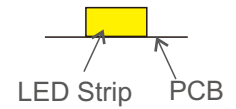

Applications:

Ideal for sign letters and channel letters, concealed lights, room lighting, equipment.

Assembly drawing:

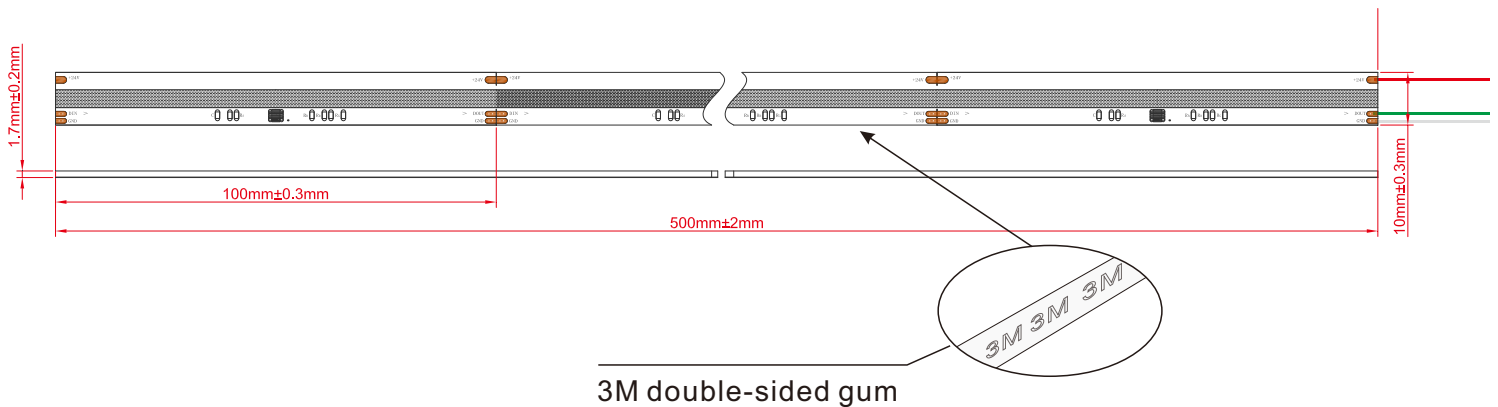

Top View



Section



Parameter:

FCOB420RGB+IC-24-M10							
Part number	Color	LED QTY/m	PCB	Lumen/m	Voltage	Power/meter	Packing means
FCOB420RGB+IC-24-M10	Red 	420	10mm	130	DC24V	13.5W	5 meters/reel
	Green 			310			
	Blue 			45			

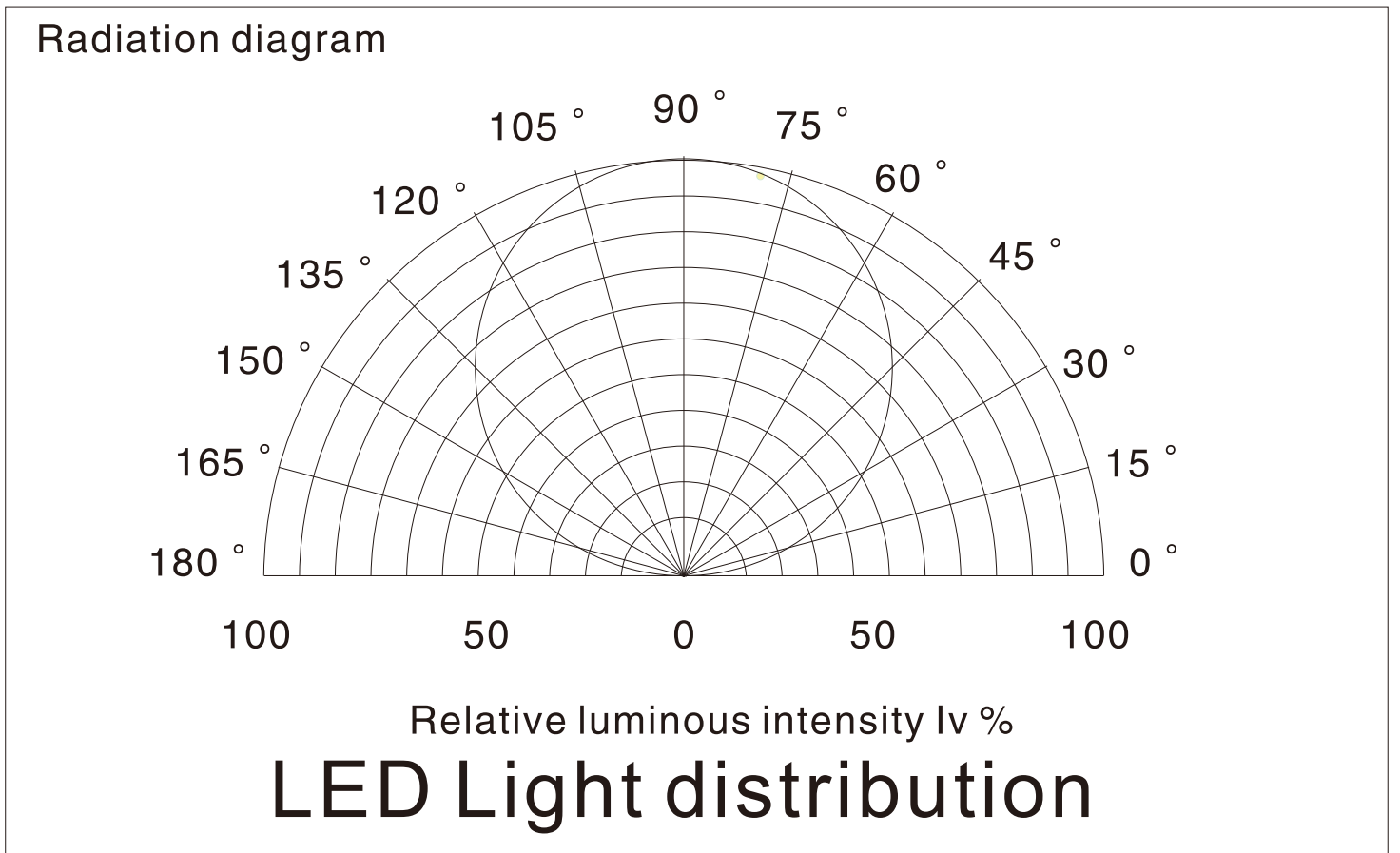

For: red, blue, green, yellow

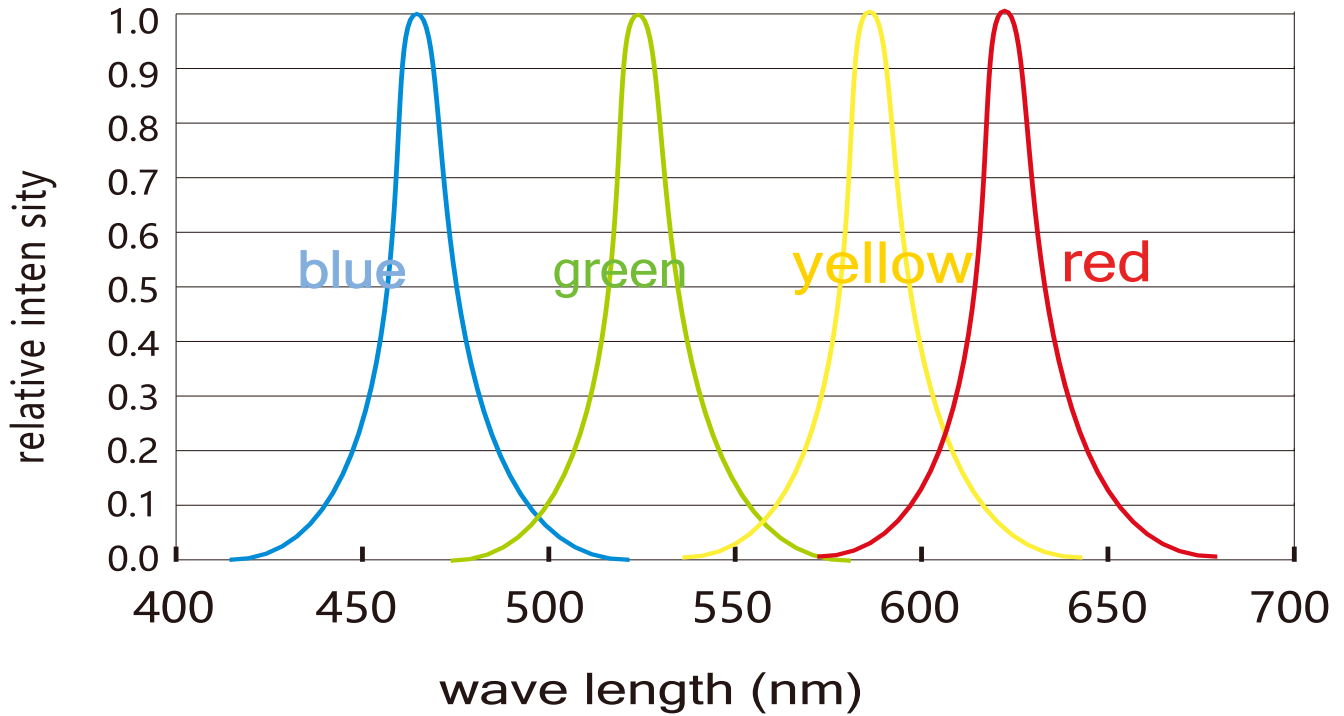

For: white LED

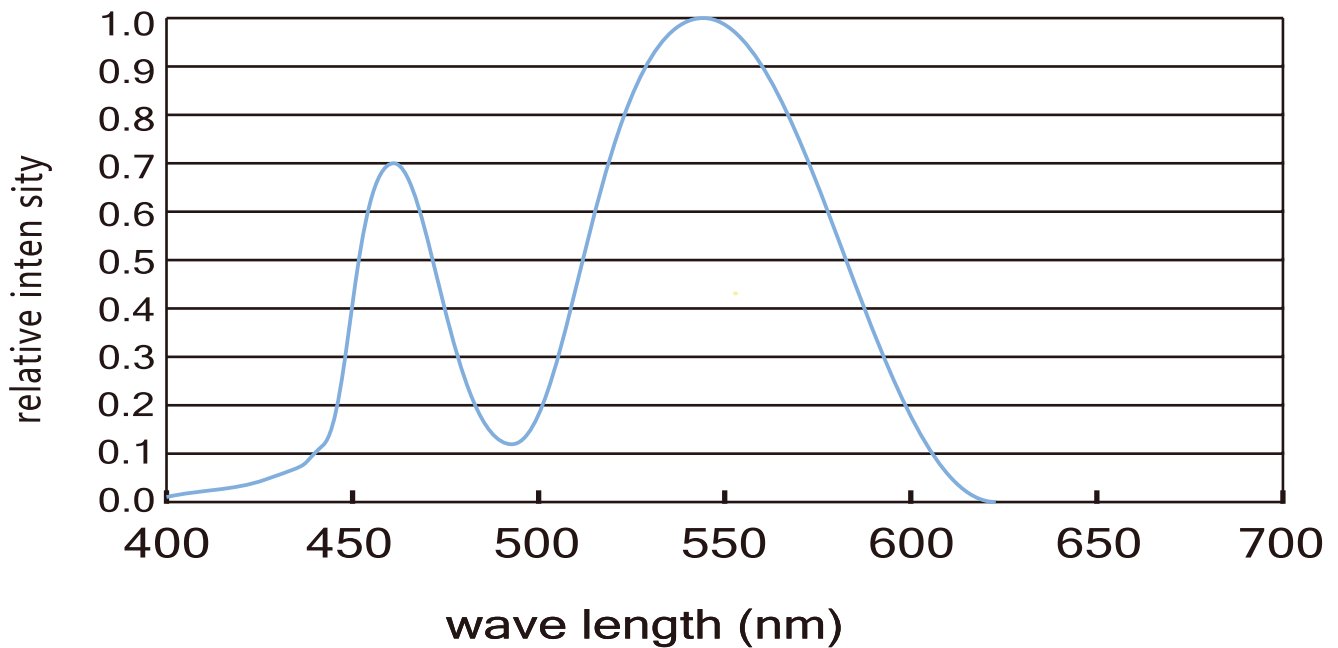

How to connect flexible strip:

1. Below shows you how to connect the flexible strip to power supplies

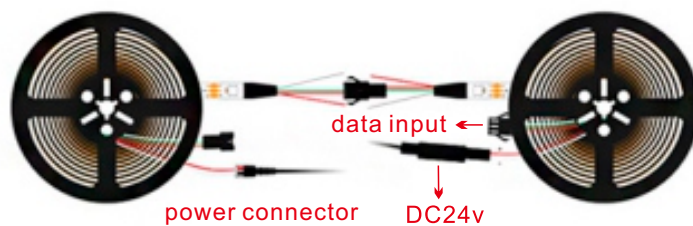
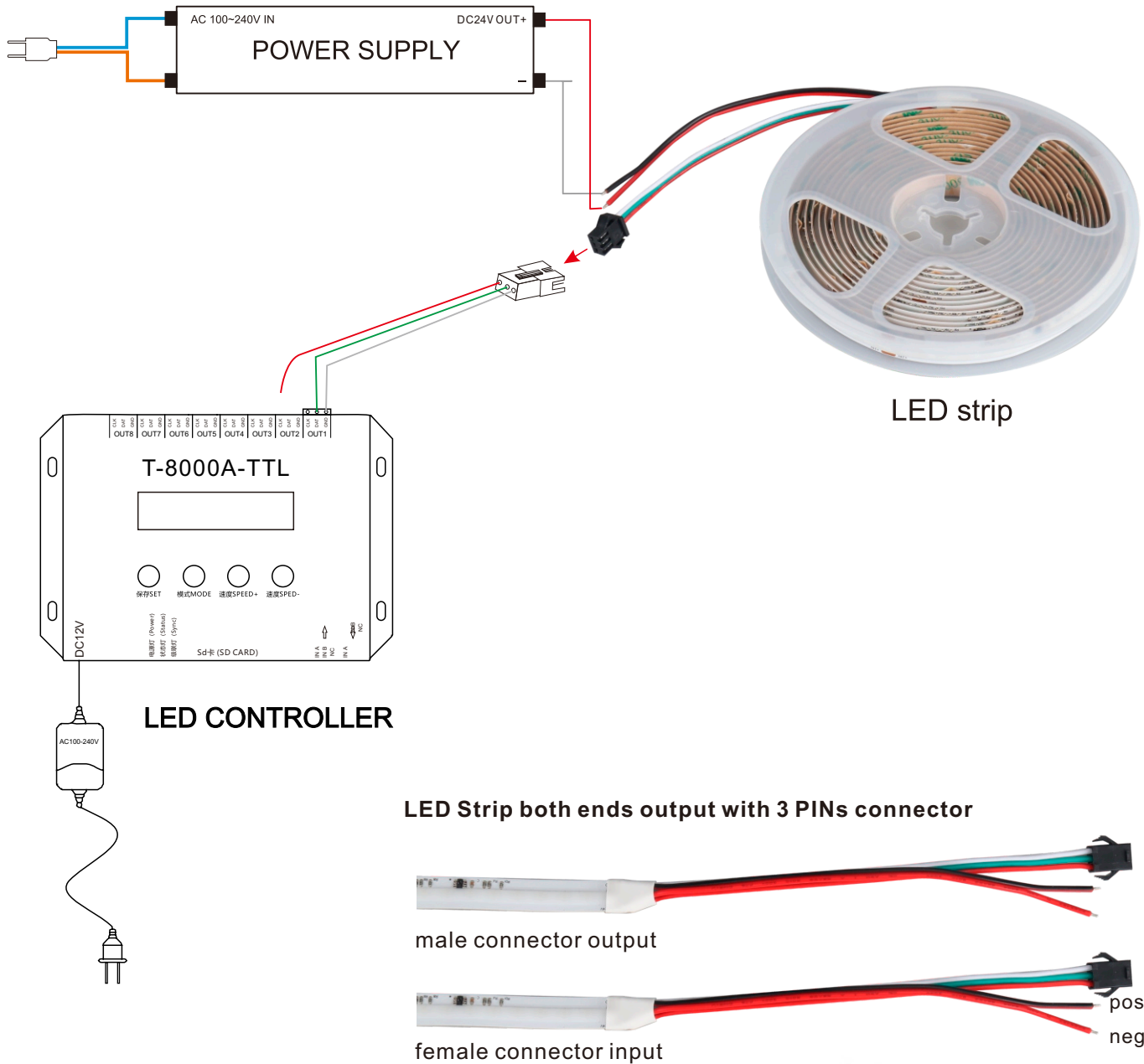

Package:



1 reel/bag



25 bags/Inner Box

Inner box
size:25x26x31cm



50 Bags/Outer Box

Outer box
size:34x52x27cm

Package: 5 meters strip in one reel, one reel in one anti-static bag, 25 bags put into one carton, 2 inner boxes put into 1 carton .

Cautions:

When install the led strip, please note the installation technique. The led strip can be bent, but not distorted, as shown below:

Distortion(Wrong)

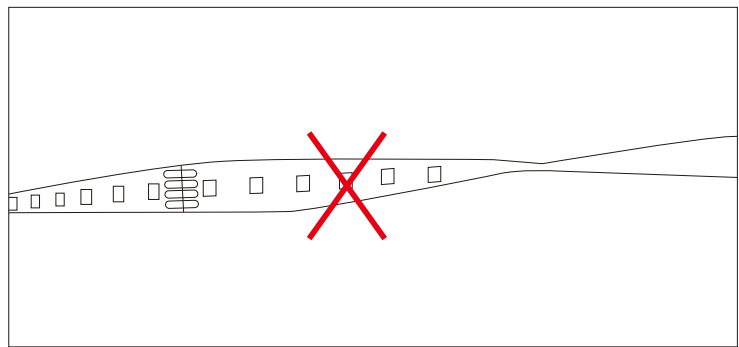
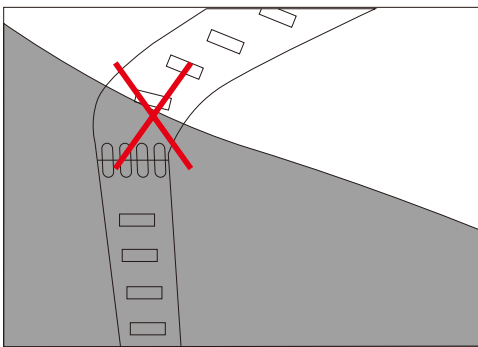
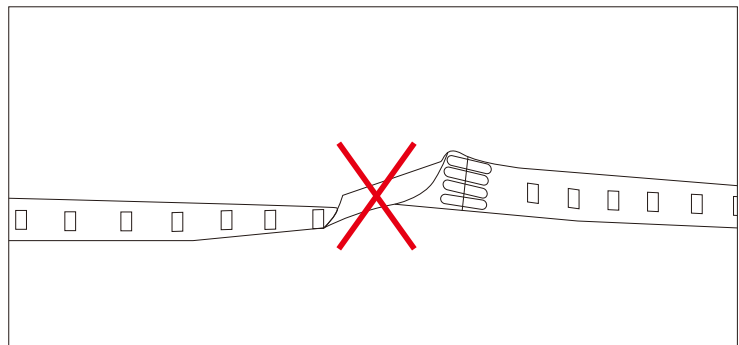
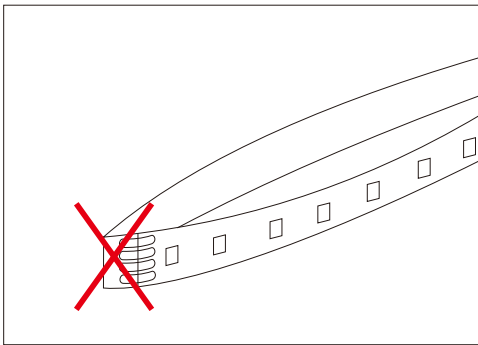

Bend (Right)

