

Features

- Top-view illumination with vertical bending, supporting a minimum bending diameter of 50 mm / 1.97".
- DC24V input with a 6mm × 6mm (0.236" × 0.236") cross-section profile.
- IP20 rated with premium silicone housing, UV-resistant and solvent-resistant for demanding environments.
- Easy to cut and install, allowing convenient on-site maintenance.
- 3-year warranty.

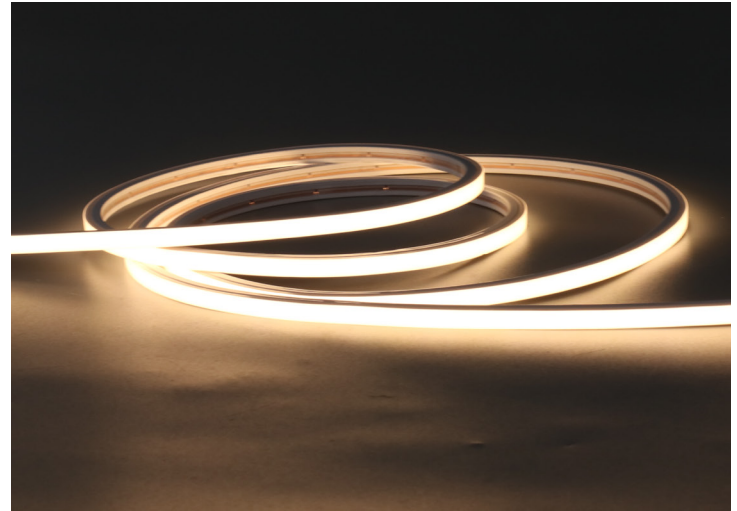

Dimension & Bending

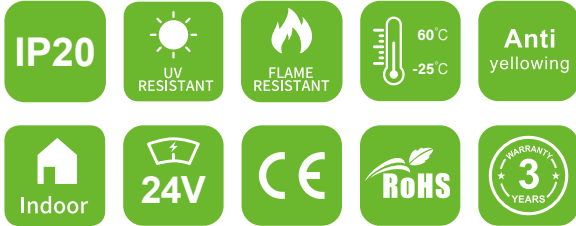
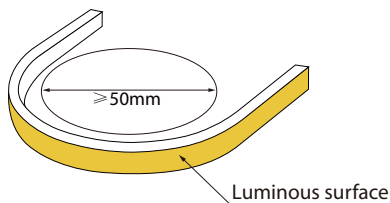
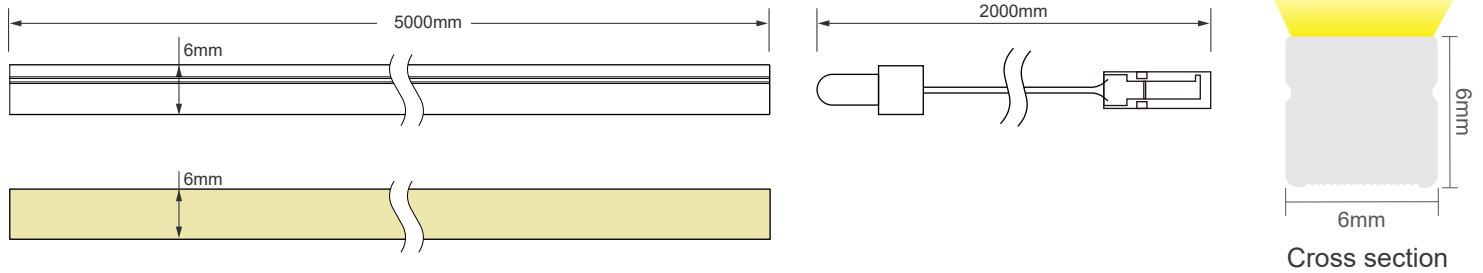

Min. Bending Diameter

Bend vertical only

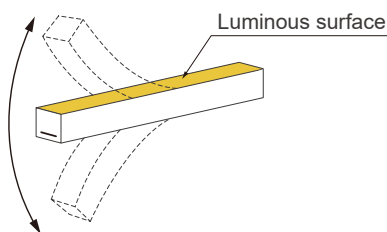

Specification

Voltage	24V
Min. Bending Diameter:	50mm
IP Grade	IP20
N.W.(G/M)	90g
Working/storage temperature:	Ta:-25~50°C/0~60°C

Due to normal production tolerances and variations in electronic components, the actual output performance and electrical parameters may vary by up to ±10%.

Recommend LED strip parameters

Single Color

Series	Color / CCT	CRI80 (Lm/M)	CRI90 (Lm/M)	Power/M	Voltage	Unit cut	Max Run
Single Color	3000/4000/6000K	826 / 864 / 854	749 / 787 / 768	9.6W	24V	cut anywhere	3m

Additional Accessories (Optional, purchase for extra)



Name	Solderless Power Cable
Model	FC-N0606D-AP
Standard Length	2m
Connector	L813 Male
Direct Plug-in Design (No Soldering Required)	



Name	Double-Ended Solderless Plug
Model	FC-N0606D-BP

Driver & Controller (Optional, purchase for extra)

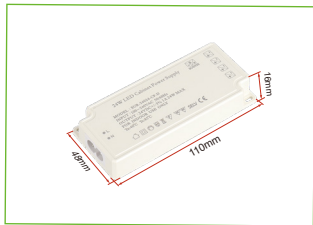

Model: SUR-24024-CP-D

- 24V / 24W max
- Ultra-thin design
- Compatible with L813 connector
- Supports up to 4 outputs
- With short circuit & overload protection

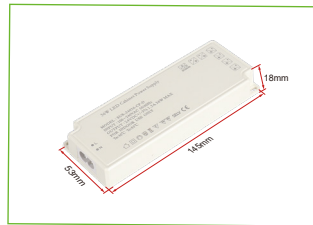

Model: SUR-24036-CP-D

- 24V / 36W max
- Constant voltage mode output;
- Voltage range (100-240VAC)
- Protection class II
- 6 outputs and 1 sensor connector
- 20000 hours Life span

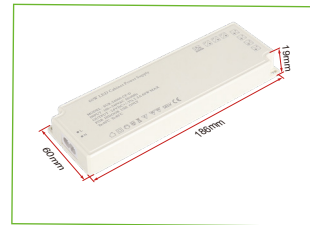

Model: SUR-24060-CP-D

- 24V / 60W max
- Ultra-thin design (18mm height)
- High current output 2.5A
- Compatible with L813 connector
- 6 outputs + 1 sensor port
- With short circuit & overload protection

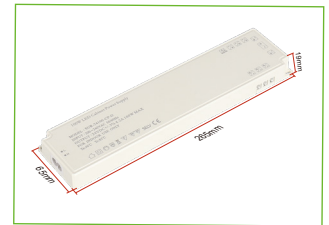

Model: SUR-24100-CP-D

- 24V / 100W max
- Ultra-thin design (19mm height)
- High current output 4.2A
- 9 outputs + 1 sensor port
- Compatible with L813 connector
- Imported IC, long-life capacitor design
- With short circuit & overload protection



Model: LRS-150-24

- AC100-120V/200-240V DC24V 150W
- IP20, Global certification
- Non Dimmable.

Cut mark



Free Cut Version: Cut Anywhere

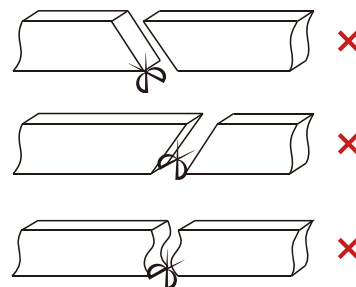

Please do not arbitrarily cut or cut into a bevel and arc section.

Product Wiring Schematic

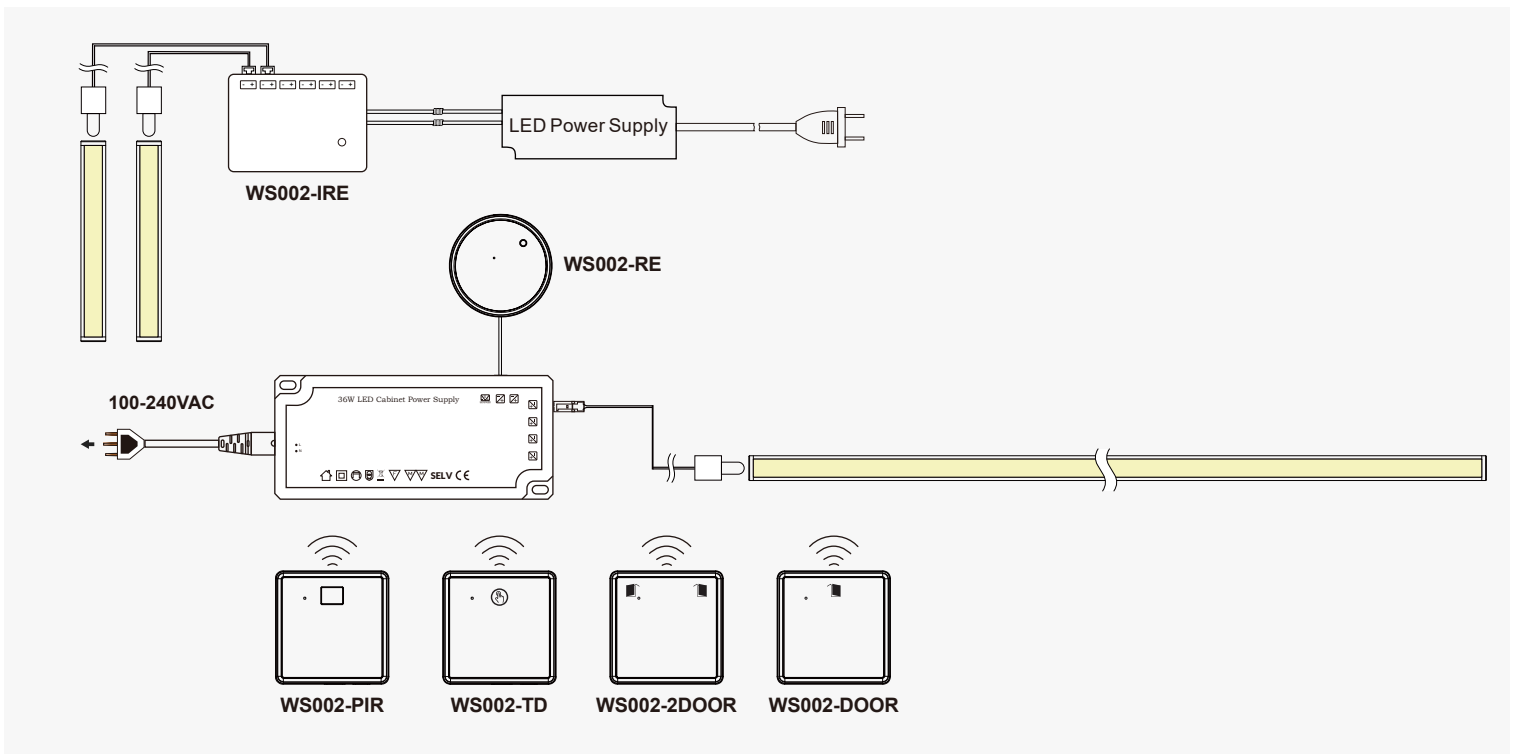
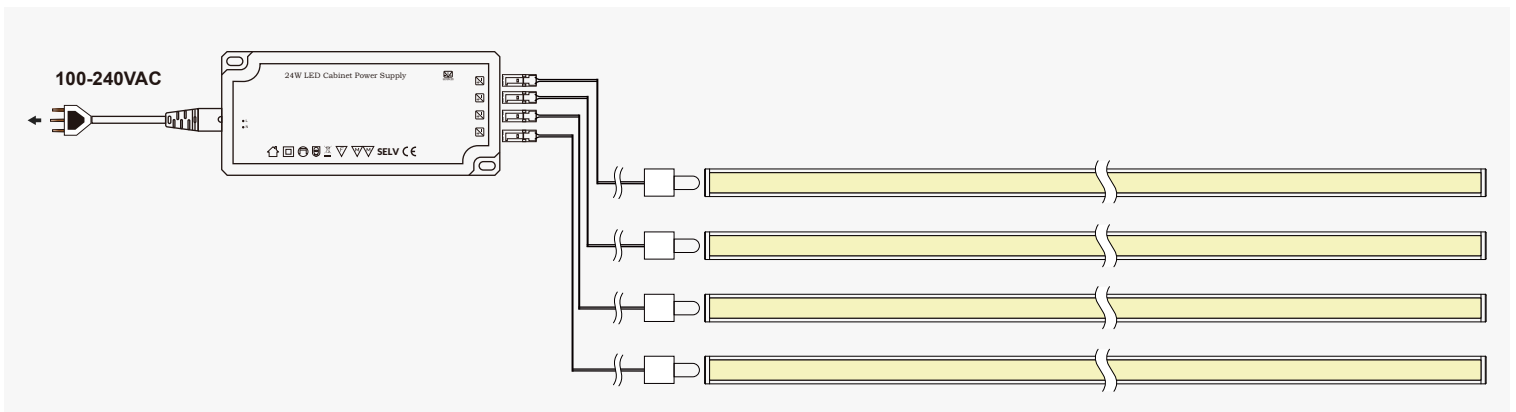

Package of neon strip (5M/Roll)

